

## SERVICE MANUAL

### TECHNICAL INFORMATION

FOR SERVICE PERSONNEL ONLY

REFER TO THE FOUNDATION MANUAL

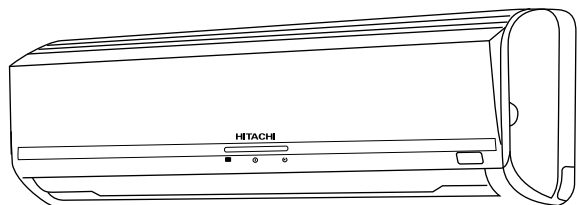

RAK-60PPA

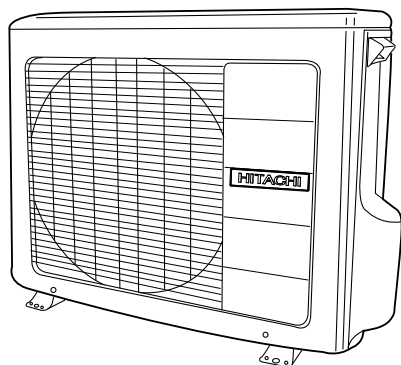

RAC-60WPA

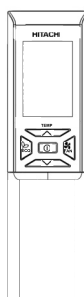

#### CONTENTS

SPECIFICATIONS-----	5
HOW TO USE -----	7
CONSTRUCTION AND DIMENSIONAL DIAGRAM-----	44
MAIN PARTS COMPONENT -----	46
WIRING DIAGRAM -----	48
CIRCUIT DIAGRAM -----	49
PRINTED WIRING BOARD LOCATION DIAGRAM -----	55
BLOCK DIAGRAM -----	58
BASIC MODE -----	59
REFRIGERATING CYCLE DIAGRAM-----	77
AUTO SWING FUNCTION -----	78
DESCRIPTION OF MAIN CIRCUIT OPERATION-----	79
SERVICE CALL Q & A-----	93
TROUBLE SHOOTING -----	97
PARTS LIST AND DIAGRAM-----	123

#### SPECIFICATIONS

TYPE	(WALL TYPE)	
	INDOOR UNIT	OUTDOOR UNIT
MODEL	RAK-60PPA	RAC-60WPA
POWER SOURCE	1 PHASE, 50/60 Hz, 220-240V	
COOLING	TOTAL INPUT (W)	1,850 (155 – 2,300)
	TOTAL AMPERES (A)	8.50 – 7.80
	CAPACITY (kW)	6.10 (0.9 – 6.5)
		(B.T.U./h)
HEATING	TOTAL INPUT (W)	1,880 (155 – 2,550)
	TOTAL AMPERES (A)	8.60 – 7.90
	CAPACITY (kW)	6.80 (0.9 – 8.5)
		(B.T.U./h)
DIMENSIONS (mm)	W	1030
	H	295
	D	207
NET WEIGHT (kg)	12	45

※ After installation

SPECIFICATIONS AND PARTS ARE SUBJECT TO CHANGE FOR IMPROVEMENT



## SPILT SYSTEM AIR CONDITIONER

Большая библиотека технической документации  
<https://splitsystema48.ru/instrukcii-po-ekspluatacii-kondicionerov.html>  
 каталоги, инструкции, сервисные мануалы, схемы.

FEBRUAR

Division

# SAFETY DURING REPAIR WORK

1. In order to disassemble and repair the unit in question, be sure to disconnect the power cord plug from the power outlet before starting the work.

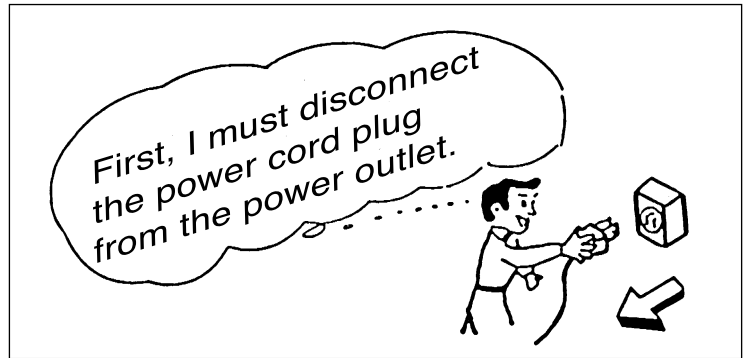

2. If it is necessary to replace any parts, they should be replaced with respective genuine parts for the unit, and the replacement must be effected in correct manner according to the instructions in the Service Manual of the unit.

If the contacts of electrical parts are defective, replace the electrical parts without trying to repair them.

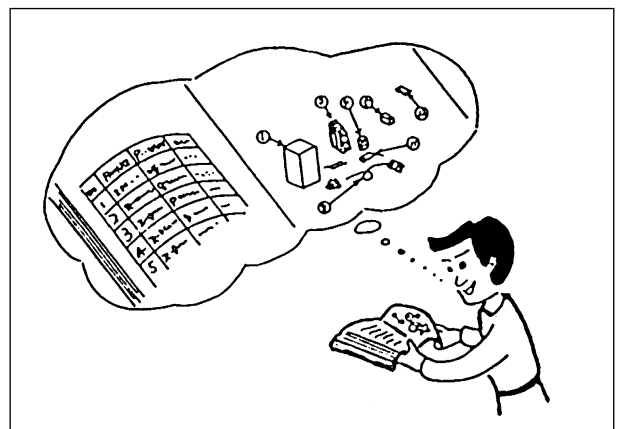

3. After completion of repairs, the initial state should be restored.
4. Lead wires should be connected and laid as in the initial state.
5. Modification of the unit by user himself should absolutely be prohibited.
6. Tools and measuring instruments for use in repairs or inspection should be accurately calibrated in advance.
7. In installing the unit having been repaired, be careful to prevent the occurrence of any accident such as electrical shock, leak of current, or bodily injury due to the drop of any part.
8. To check the insulation of the unit, measure the insulation resistance between the power cord plug and grounding terminal of the unit. The insulation resistance should be  $1M\Omega$  or more as measured by a 500V DC megger.
9. The initial location of installation such as window, floor or the other should be checked for being and safe enough to support the repaired unit again. If it is found not so strong and safe, the unit should be installed at the initial location reinforced or at a new location.
10. Any inflammable thing should never be placed about the location of installation.
11. Check the grounding to see whether it is proper or not, and if it is found improper, connect the grounding terminal to the earth.



## WORKING STANDARDS FOR PREVENTING BREAKAGE OF SEMICONDUCTORS

### 1. Scope

The standards provide for items to be generally observed in carrying and handling semiconductors in relative manufacturers during maintenance and handling thereof. (They apply the same to handling of abnormal goods such as rejected goods being returned).

### 2. Object parts

- (1) Micro computer
- (2) Integrated circuits (IC)
- (3) Field-effect transistors (FET)
- (4) P.C. boards or the like on which the parts mentioned in (1) and (2) of this paragraph are equipped.

### 3. Items to be observed in handling

- (1) Use a conductive container for carrying and storing of parts. (Even rejected goods should be handled in the same way).

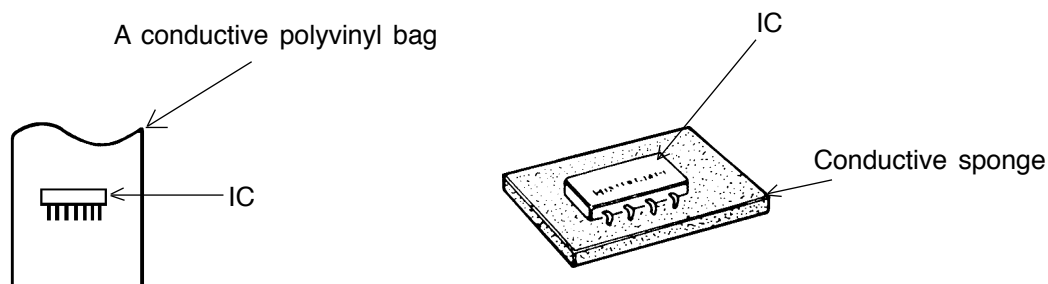

Fig. 1. Conductive Container

- (2) When any part is handled uncovered (in counting, packing and the like), the handling person must always use himself as a body earth. (Make yourself a body earth by passing  $1M\Omega$  (earth resistance through a ring or bracelet).
- (3) Be careful not to touch the parts with your clothing when you hold a part even if a body earth is being taken.
- (4) Be sure to place a part on a metal plate with grounding.
- (5) Be careful not to fail to turn off power when you repair the printed circuit board. At the same time, try to repair the printed circuit board on a grounded metal plate.

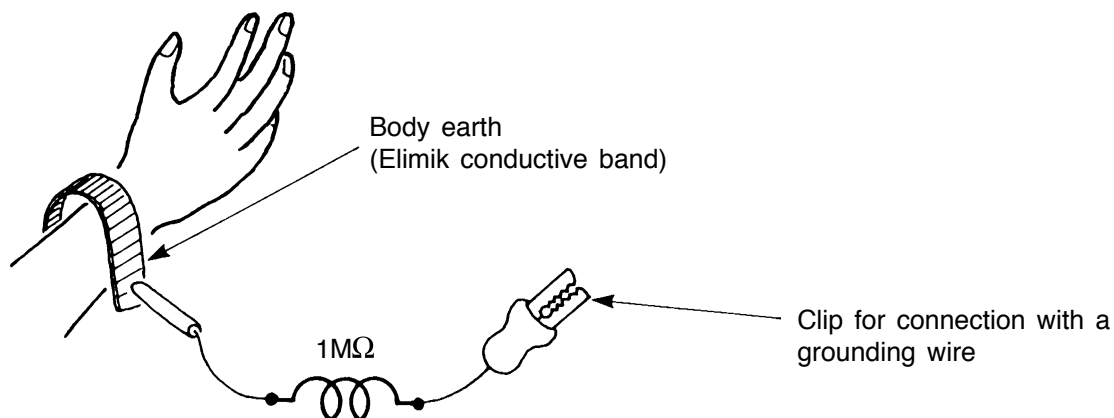

Fig. 2. Body Earth

(6) Use a three wire type soldering iron including a grounding wire.

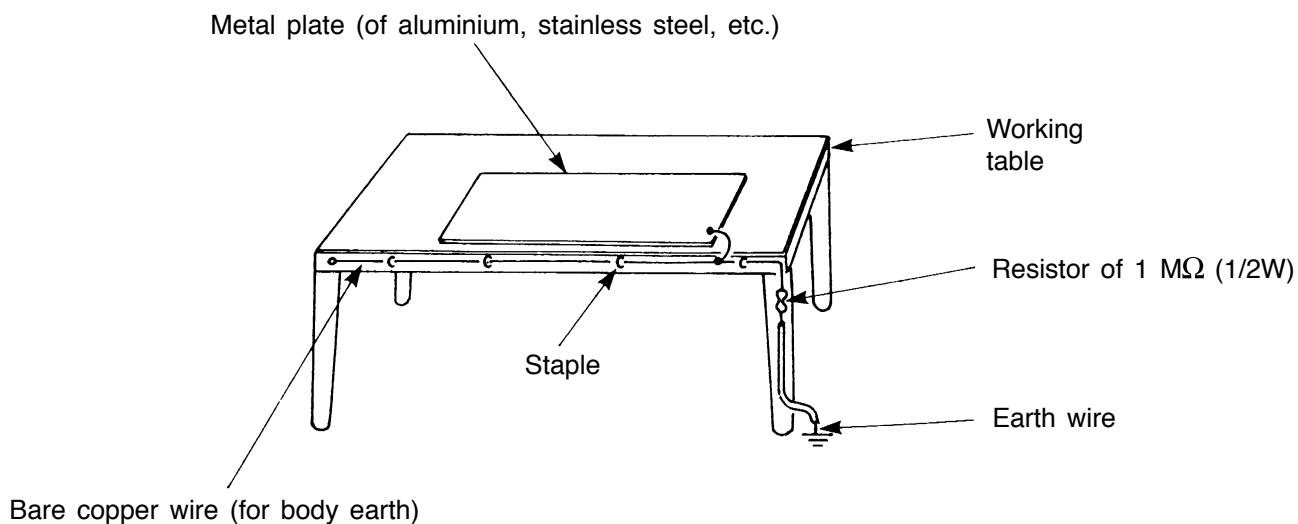

Fig. 3. Grounding of the working table

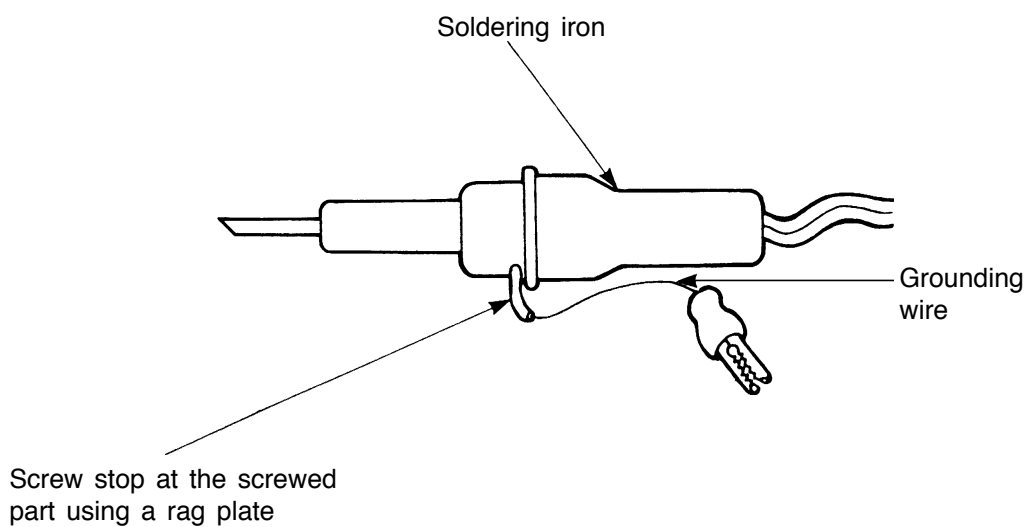

Fig. 4. Grounding a soldering iron

Use a high insulation mode (100V, 10MΩ or higher) when ordinary iron is to be used.

(7) In checking circuits for maintenance, inspection or some others, be careful not to have the test probes of the measuring instrument shortcircuit a load circuit or the like.

**⚠ CAUTION**

1. In quiet or stop operation, slight flowing noise of refrigerant in the refrigerating cycle is heard occasionally, but this noise is not abnormal for the operation.
2. When it thunders near by, it is recommend to stop the operation and to disconnect the power cord plug from the power outlet for safety.
3. In the event of power failure, the air conditioner will restart automatically in the previously selected mode once the power is restored. In the event of power failure during TIMER operation, the air conditioner will not start automatically. Re-press ON/OFF button after 3 minutes from when the unit off or power recovery.
4. If the room air conditioner is stopped by adjusting thermostat, or missoperation, and re-start in a moment, there is occasion that the cooling and heating operation does not start for 3 minutes, it is not abnormal and this is the result of the operation of IC delay circuit. This IC delay circuit ensures that there is no danger of blowing fuse or damaging parts even if operation is restarted accidentally.
5. This room air conditioner should not be used at the cooling operation when the outside temperature is below  $-10^{\circ}\text{C}$  ( $14^{\circ}\text{F}$ ).
6. This room air conditioner (the reverse cycle) should not be used when the outside temperature is below  $-15^{\circ}\text{C}$  ( $5^{\circ}\text{F}$ ).  
If the reverse cycle is used under this condition, the outside heat exchanger is frosted and efficiency falls.
7. When the outside heat exchanger is frosted, the frost is melted by operating the hot gas system, it is not trouble that at this time fan stops and the vapour may rise from the outside heat exchanger.

## SPECIFICATIONS

MODEL		RAK-60PPA	RAC-60WPA
FAN MOTOR		38 W	47 W
FAN MOTOR CAPACITOR		NO	NO
FAN MOTOR PROTECTOR		NO	NO
COMPRESSOR		–	JU1015D9
COMPRESSOR MOTOR CAPACITOR		NO	NO
OVERLOAD PROTECTOR		NO	YES (INTERNAL)
OVERHEAT PROTECTOR		NO	YES
FUSE (for MICROPROCESSOR)		3.15A	3.15A
POWER RELAY		G4A	G4A
POWER SWITCH		NO	NO
TEMPORARY SWITCH		YES	NO
TEST/SERVICE SWITCH		NO	YES
TRANSFORMER		NO	NO
VARISTOR		416NR	450NR
NOISE SUPPRESSOR		NO	YES
THERMOSTAT		YES(IC)	YES(IC)
REMOTE CONTROL SWITCH (LIQUID CRYSTAL)		YES	NO
REFRIGERANT CHARGING VOLUME (Refrigerant R410A)	UNIT	-----	* 1650g
	PIPES (MAX. 30m) (MIN. 3m)	ADDITIONAL REFRIGERANT R410A AT 10g PER EVERY METER IF PIPE LENGTH MORE THAN 8m.	

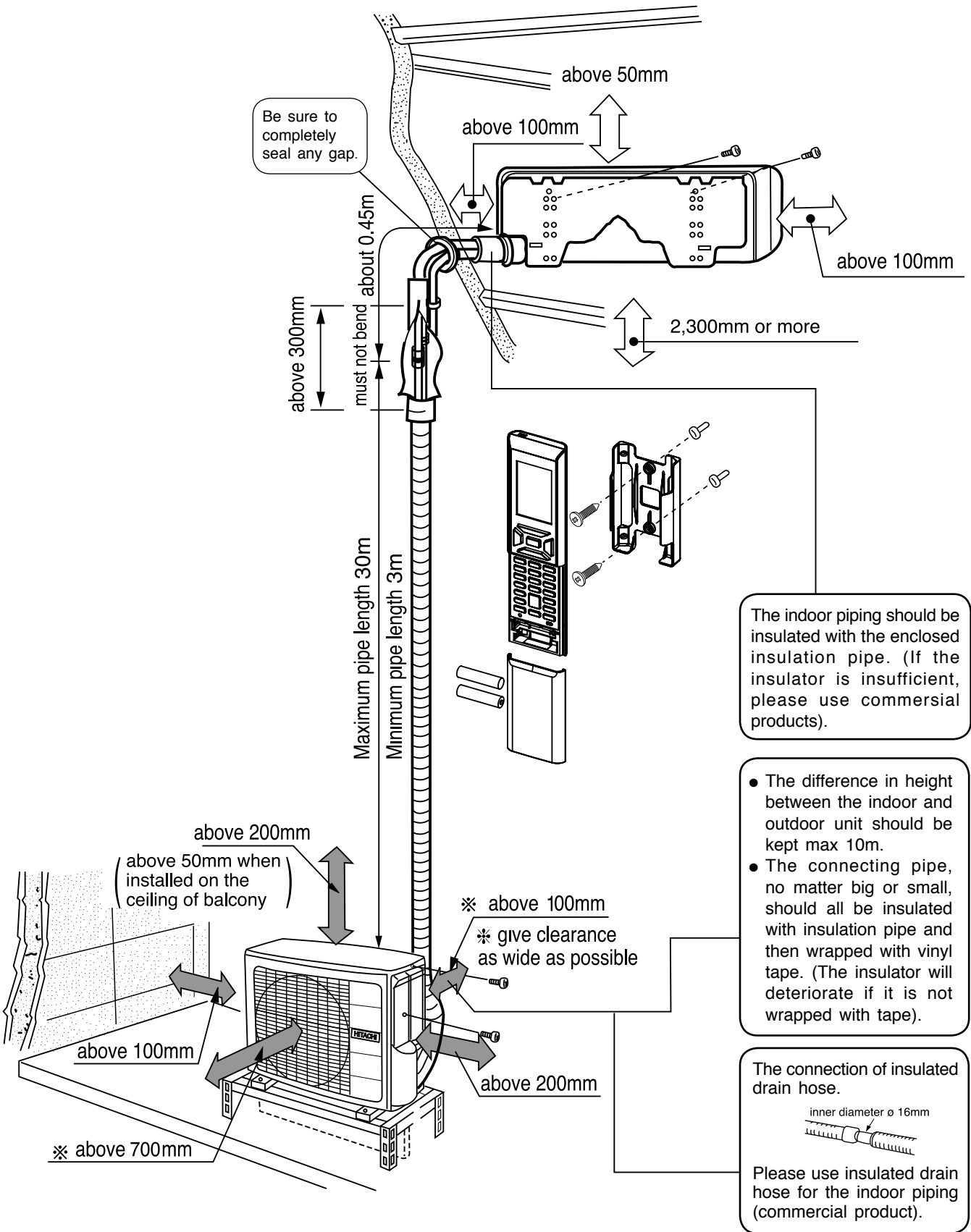

Figure showing the installation of Indoor and Outdoor unit









# SAFETY PRECAUTION

- Please read the “Safety Precaution” carefully before operating the unit to ensure correct usage of the unit.
- Pay special attention to signs of “**▲ Warning**” and “**▲ Caution**”. The “Warning” section contains matters which, if not observed strictly, may cause death or serious injury. The “Caution” section contains matters which may result in serious consequences if not observed properly. Please observe all instructions strictly to ensure safety.
- The sign indicate the following meanings.



 Make sure to connect earth line.	 The sign in the figure indicates prohibition.
 Indicates the instructions that must be followed.	

- Please keep this manual after reading.







## PRECAUTIONS DURING INSTALLATION

<b>WARNING</b> 	<ul style="list-style-type: none"> <li>● Do not reconstruct the unit. Water leakage, fault, short circuit or fire may occur if you reconstruct the unit by yourself. </li> <li>● Please ask your sales agent or qualified technician for the installation of your unit. Water leakage, short circuit or fire may occur if you install the unit by yourself.</li> </ul>
	<ul style="list-style-type: none"> <li>● Please use earth line. Do not place the earth line near water or gas pipes, lightning-conductor, or the earth line of telephone. Improper installation of earth line may cause electric shock. </li> <li>● Be sure to use the specified piping set for R410A. Otherwise, this may result in broken copper pipes or faults.</li> </ul>
	<ul style="list-style-type: none"> <li>● A circuit breaker should be installed depending on the mounting site of the unit. Without a circuit breaker, the danger of electric shock exists.</li> <li>● Do not install near location where there is flammable gas. The outdoor unit may catch fire if flammable gas leaks around it. </li> <li>● Please ensure smooth flow of water when installing the drain hose.</li> <li>● Do not install the indoor unit in a machine shop or kitchen where vapor from oil or its mist flows to the indoor unit. The oil will deposit on the heat exchanger, thereby reducing the indoor unit performance and may deform and in the worst case, break the plastic parts of the indoor unit.</li> </ul>

## PRECAUTIONS DURING SHIFTING OR MAINTENANCE

<b>WARNING</b> 	<ul style="list-style-type: none"> <li>● Should abnormal situation arises (like burning smell), please stop operating the unit and turn off the circuit breaker. Contact your agent. Fault, short circuit or fire may occur if you continue to operate the unit under abnormal situation. </li> </ul>
	<ul style="list-style-type: none"> <li>● Please contact your agent for maintenance. Improper self maintenance may cause electric shock and fire.</li> </ul>
	<ul style="list-style-type: none"> <li>● Please contact your agent if you need to remove and reinstall the unit. Electric shock or fire may occur if you remove and reinstall the unit yourself improperly.</li> </ul>
	<ul style="list-style-type: none"> <li>● If the supply cord is damaged, it must be replaced by the special cord obtainable at authorized service/parts centers.</li> </ul>

## PRECAUTIONS DURING OPERATION

<b>WARNING</b> 	<ul style="list-style-type: none"> <li>● Avoid an extended period of direct air flow for your health. </li> </ul>
	<ul style="list-style-type: none"> <li>● Do not insert a finger, a rod or other objects into the air outlet or inlet. As the fan is rotating at a high speed, it will cause injury. Before cleaning, be sure to stop the operation and turn the breaker OFF. </li> </ul>
	<ul style="list-style-type: none"> <li>● Do not use any conductor as fuse wire, this could cause fatal accident. </li> </ul>
	<ul style="list-style-type: none"> <li>● During thunder storm, disconnect and turn off the circuit breaker. </li> </ul>
	<ul style="list-style-type: none"> <li>● Spray cans and other combustibles should not be located within a meter of the air outlets of both indoor and outdoor units. As a spray can's internal pressure can be increased by hot air, a rupture may result. </li> </ul>



## PRECAUTIONS DURING OPERATION

- The product shall be operated under the manufacturer specification and not for any other intended use.



- Do not attempt to operate the unit with wet hands, this could cause fatal accident.

- When operating the unit with burning equipments, regularly ventilate the room to avoid oxygen insufficiency.

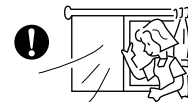

- Do not direct the cool air coming out from the air-conditioner panel to face household heating apparatus as this may affect the working of apparatus such as the electric kettle, oven etc.

- Please ensure that outdoor mounting frame is always stable, firm and without defect. If not, the outdoor unit may collapse and cause danger.



- Do not splash or direct water to the body of the unit when cleaning it as this may cause short circuit.



- Do not use any aerosol or hair sprays near the indoor unit. This chemical can adhere on heat exchanger fin and blocked the evaporation water flow to drain pan. The water will drop on tangential fan and cause water splashing out from indoor unit.



- Please switch off the unit and turn off the circuit breaker during cleaning, the high-speed fan inside the unit may cause danger.



- Turn off the circuit breaker if the unit is not to be operated for a long period.



- Do not climb on the outdoor unit or put objects on it.

- Do not put water container (like vase) on the indoor unit to avoid water dripping into the unit. Dripping water will damage the insulator inside the unit and causes short-circuit.

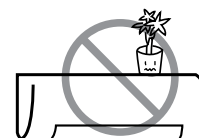

- Do not place plants directly under the air flow as it is bad for the plants.

- When operating the unit with the door and windows opened, (the room humidity is always above 80%) and with the air deflector facing down or moving automatically for a long period of time, water will condense on the air deflector and drips down occasionally. This will wet your furniture. Therefore, do not operate under such condition for a long time.

- If the amount of heat in the room is above the cooling or heating capability of the unit (for example: more people entering the room, using heating equipments and etc.), the preset room temperature cannot be achieved.

- This appliance is not intended for use by young children or infirm persons unless they have been adequately supervised by a responsible person to ensure that they can use the appliance safely.
- Young children should be supervised to ensure that they do not play with the appliance.



C  
A  
U  
T  
I  
O  
N

# NAMES AND FUNCTIONS OF EACH PART

## INDOOR UNIT

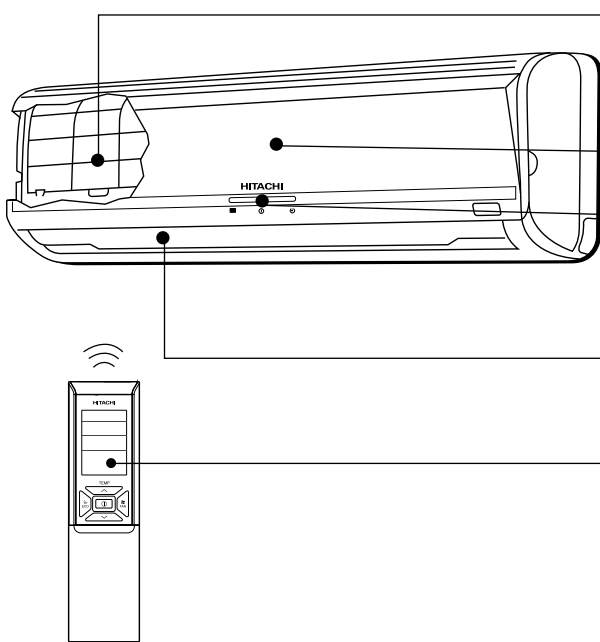

### PRE-FILTER

To prevent dust from coming into the indoor unit. (Refer page 15)

### FRONT PANEL

### INDOOR UNIT INDICATORS

Light indicator showing the operating condition. (Refer page 10)

### HORIZONTAL DEFLECTOR • VERTICAL DEFLECTOR (AIR OUTLET)

### REMOTE CONTROLLER

Send out operation signal to the indoor unit. So as to operate the whole unit. (Refer Remote control manual)

## NOTE

- Air purifying filters are not washable. It is recommended to use vacuum to clean it. It can be use for 1 year time. Type number for this air purifying filter is <SPX-NTW1>. Please use this number for ordering when you want to replace it.

## OUTDOOR UNIT

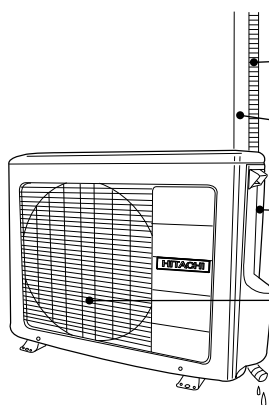

### DRAIN PIPE

Condensed water drain to outside.

### CONNECTING CORD

### AIR INLET (BACK, LEFT SIDE)

### AIR OUTLET

## MODEL NAME AND DIMENSIONS

MODEL	WIDTH (mm)	HEIGHT (mm)	DEPTH (mm)
RAK-60PPA	1030	295	207
RAC-60WPA	850	650	298

## INDOOR UNIT INDICATORS

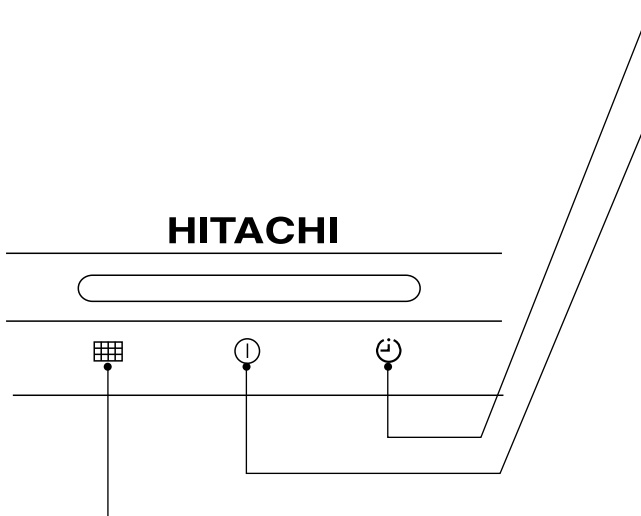

### TIMER LAMP

This lamp lights when the timer is working.

### OPERATION LAMP

This lamp lights during operation.

The OPERATION LAMP flashes in the following cases during heating.

#### (1) During preheating

For about 2–3 minutes after starting up.

#### (2) During defrosting

Defrosting will be performed about once an hour when frost forms on the heat exchanger of the outdoor unit, for 5–10 minutes each time.

### FILTER LAMP

When the device is operated for a total of about 200 hours, the FILTER lamp lights to indicate that it is time to clean the filter. The lamp goes out when the “ (AUTO SWING)” button is pressed while the device is on “STANDBY MODE”.

## OPERATION INDICATOR

- This figure shows the opening condition of front panel. Refer to page 9 in relation to how to open or close the front panel.

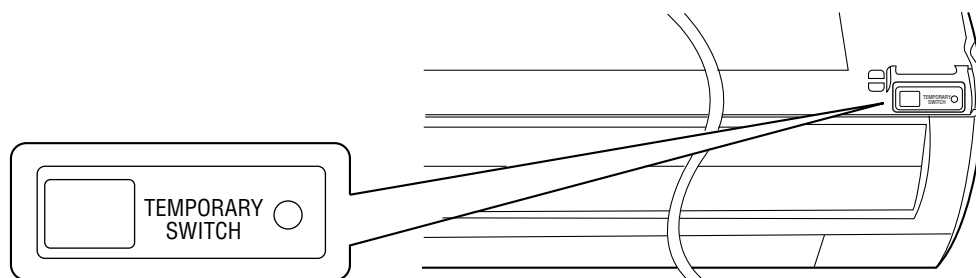

## TEMPORARY SWITCH

Use this switch to start and stop when the remote controller does not work. [Use non-conductor stick (example: toothpick)]

- By pressing the temporary switch, the operation is done in automatic mode.
- When the operation is done using the temporary switch after the power source is turned off and turn on again, the operation is done in automatic mode.



# THE IDEAL WAYS OF OPERATION

## Suitable Room Temperature

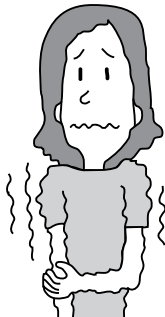

**⚠ Warning**  
Freezing temperature is bad for health and a waste of electric power.

## Install curtain or blinds

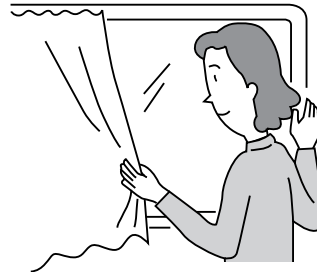

It is possible to reduce heat entering the room through windows.

## Ventilation

**⚠ Caution**  
Do not close the room for a long period of time. Occasionally open the door and windows to allow the entrance of fresh air.

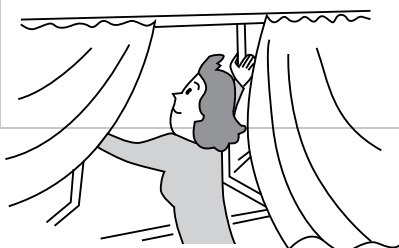

## Effective Usage Of Timer

At night, please use the “OFF or ON timer operation mode”, together with your wake up time in the morning. This will enable you to enjoy a comfortable room temperature. Please use the timer effectively.

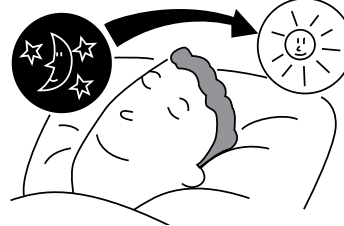

## Do Not Forget To Clean The Pre-Filter

Dusty pre-filter will reduce the air volume and the cooling efficiency. To prevent from wasting electric energy, please clean the pre-filter every 2 weeks.

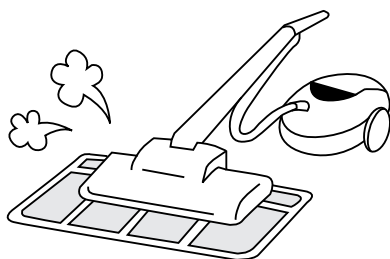

## Please Adjust Suitable Temperature For Baby And Children

Please pay attention to the room temperature and air flow direction when operating the unit for baby, children and old folks who have difficulty in movement.

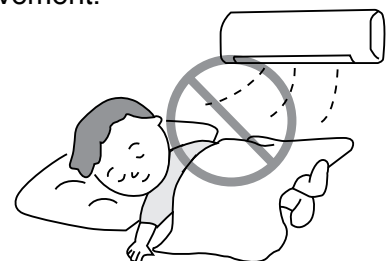

# FOR USER'S INFORMATION

## The Air Conditioner And The Heat Source In The Room

### ⚠ Caution

If the amount of heat in the room is above the cooling capability of the air conditioner (for example: more people entering the room, using heating equipments and etc.), the preset room temperature cannot be achieved.

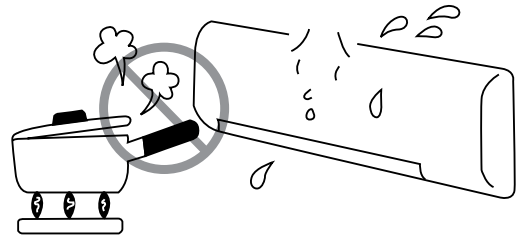

## Not Operating For A Long Time

When the indoor unit is not to be used for a long period of time, please switch off the power from the mains. If the power from mains remains "ON", the indoor unit still consumes about 12W in the operation control circuit even if it is in "OFF" mode.

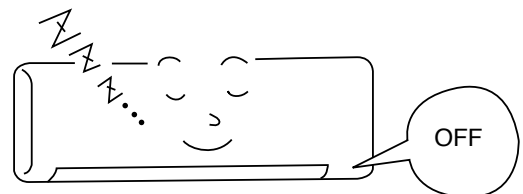

## When Lightning Occurs

### ⚠ Warning

To protect the whole unit during lightning, please stop operating the unit and remove the plug from the socket.

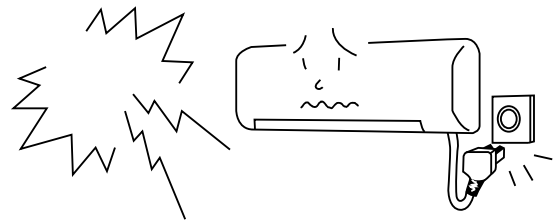

## Interference From Electrical Products

### ⚠ Caution

To avoid noise interference, please place the indoor unit and its remote controller at least 1m away from electrical products.

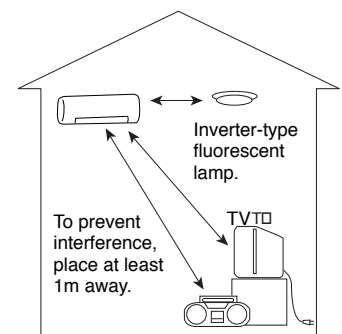

# ATTACHING THE AIR PURIFYING FILTERS

## CAUTION

Cleaning and maintenance must be carried out when filter lamp lights. Before cleaning, stop operation and switch off the power supply.

### 1 Open the front panel

- Pull up the front panel by holding it at both sides with both hands.

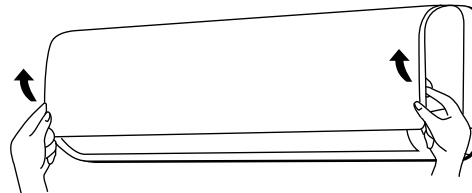

### 2 Remove the Pre-filter

- Push upward to release the claws and pull out the Pre-filter.

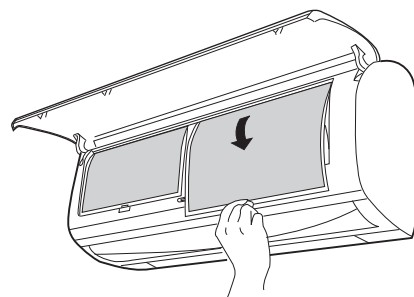

### 3 Attaching the air purifying filters

- Attach the air purifying filters to the frame by gently compress its both sides and release after insertion into Pre-filter frame.

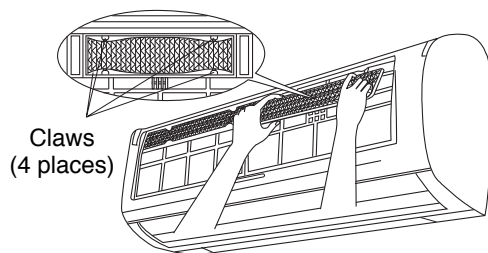

## CAUTION

Do not bend the air purifying filter as it may cause damage to the structure.

Please do not smell direct from source of filter.

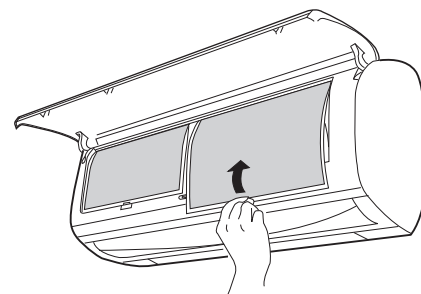

### 4 Attach the Pre-filters

- Attach the Pre-filters by ensuring that the surface written "FRONT" is facing front.
- After attaching the Pre-filters, push the front panel at three arrow portions as shown in figure and close it.

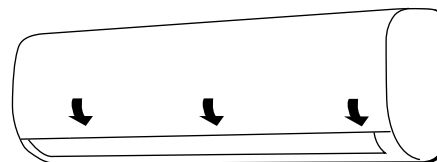

## NOTE

- In case of removing the air purifying filters, please follow the above procedures.
- The cooling capacity is slightly weakened and the cooling speed becomes slower when the air purifying filters are used. So, set the fan speed to "HIGH" when using it in this condition.
- Air purifying filters are not washable. It is recommended to use vacuum to clean it. It can be use for 1 year time. Type number for this air purifying filter is <SPX-NTW1>. Please use this number for ordering when you want to renew it.
- Do not operate the air conditioner without Pre-filter. Dust may enter the air conditioner and fault may occur.

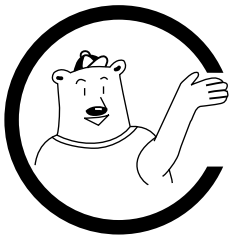

## MAINTENANCE

### **CAUTION**

Cleaning and maintenance must be carried out only by qualified service personal. Before cleaning, stop operation and switch off the power supply.

### 1. PRE-FILTER

Clean the Pre-filter, as it removes dust inside the room. In case the Pre-filter is full of dust, the air flow will decrease and the cooling capacity will be reduced. Further, noise may occur. Be sure to clean the Pre-filter following the procedure below.

#### PROCEDURE

- 1 Open the front panel and remove the Pre-filter
  - Gently lift and remove the air purifying filters from the air purifying filter frame.

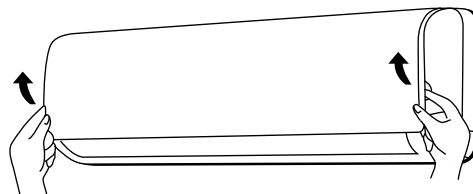

- 2 Vacuum dust from the Pre-filter and air purifying filter using vacuum cleaner. If there is too much dust, rinse under running tap water and gently brush it with soft bristle brush. Allow filters to dry in shade.

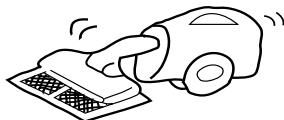
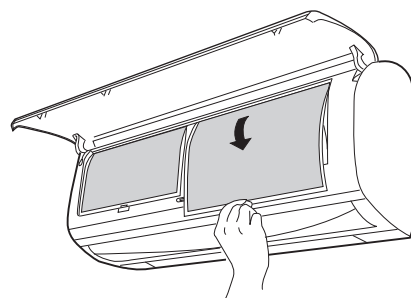

- 3
  - Re-insert the air purifying filter to the filter frame. Set the Pre-filter with "FRONT" mark facing front, and slot them into the original state.
  - After attaching the Pre-filters, push the front panel at three arrow portions as shown in figure and close it.

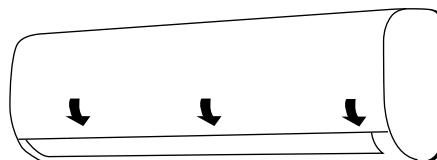

### **CAUTION**

- Do not wash with hot water at more than 40°C. The pre-filter may shrink.
- When washing it, shake off moisture completely and dry it in the shade; do not expose it directly to the sun. The pre-filter may shrink.



## 2. Washable Front Panel

- Remove the front panel and wash with clean water. Wash it with a soft sponge. After using neutral detergent, wash thoroughly with clean water.
- When front panel is not removed, wipe it with a soft dry cloth. Wipe the remote controller thoroughly with a soft dry cloth.
- Wipe the water thoroughly. If water remains at indicators or signal receiver of indoor unit, it causes trouble.

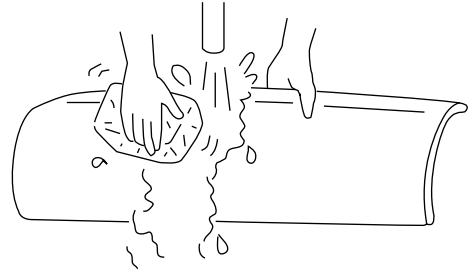

Method of removing the front panel.

Be sure to hold the front panel with both hands to detach and attach it.

### Removing the Front Panel

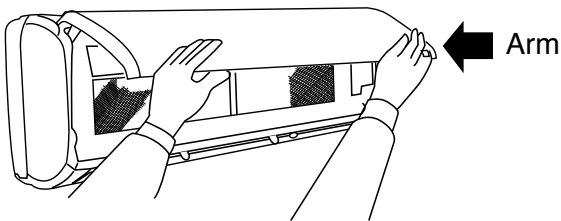

- When the front panel is fully opened with both hands, push the right arm to the outside to release it, and while closing the front panel slightly, pull it out forward.

### Attaching the Front Panel

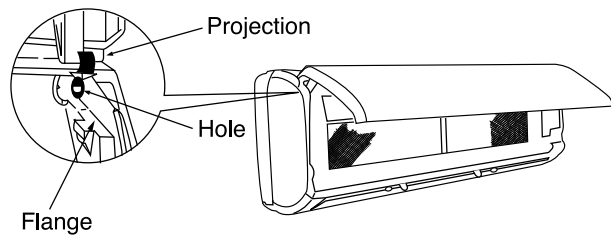

- Move the projections of the left and right arms into the **Flanges** in the unit and securely insert them into the holes.

### ⚠ CAUTION

- Do not splash or direct water to the body of the unit when cleaning it as this may cause short circuit.
- Never use hot water (above 40°C), benzine, gasoline, acid, thinner or a brush, because they will damage the plastic surface and the coating.



### **CAUTION**

Cleaning and maintenance must be carried out only by qualified service personnel. Before cleaning, stop operation and switch off the power supply.

### **3. MAINTENANCE AT BEGINNING OF LONG OFF PERIOD**

- Run the unit by setting the operation mode to  (COOL), the temperature to 32°C and the fan speed to HI for about half a day on a fine day, and dry the whole of the unit.
- Switch off the power plug.

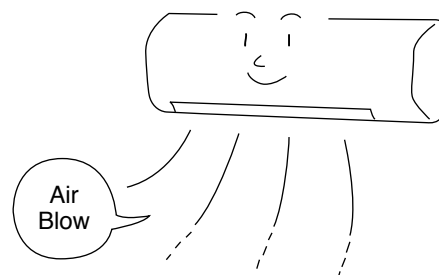

## **REGULAR INSPECTION**

PLEASE CHECK THE FOLLOWING POINTS BY QUALIFIED SERVICE PERSONNEL EITHER EVERY HALF YEARLY OR YEARLY. CONTACT YOUR SALES AGENT OR SERVICE SHOP.

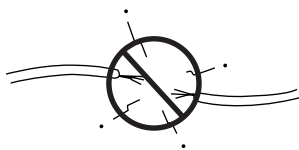
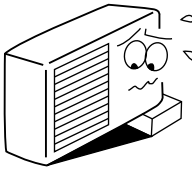
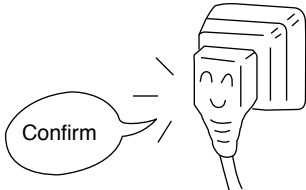
<b>1</b>		Is the earth line disconnected or broken?
<b>2</b>		Is the mounting frame seriously affected by rust and is the outdoor unit tilted or unstable?
<b>3</b>		Is the plug of power line firmly plugged into the socket? (Please ensure no loose contact between them).

# AFTER SALE SERVICE AND WARRANTY

## WHEN ASKING FOR SERVICE, CHECK THE FOLLOWING POINTS.

CONDITION	CHECK THE FOLLOWING POINTS
<p>If the remote controller is not transmitting a signal. (Remote controller display is dim or blank.)</p>	<ul style="list-style-type: none"> <li>● Do the batteries need replacement?</li> <li>● Is the polarity of the inserted batteries correct?</li> </ul>
<p>When it does not operate</p>	<ul style="list-style-type: none"> <li>● Is the fuse all right?</li> <li>● Is the voltage extremely high or low?</li> <li>● Is the circuit breaker "ON"?</li> <li>● Is the setting of operation mode different from other indoor units?</li> </ul>
<p>When it does not cool well When it does not heat well</p>	<ul style="list-style-type: none"> <li>● Is the pre-filter blocked with dust?</li> <li>● Does sunlight fall directly on the outdoor unit?</li> <li>● Is the air flow of the outdoor unit obstructed?</li> <li>● Are the doors or windows opened, or is there any source of heat in the room?</li> <li>● Is the set temperature suitable?</li> <li>● Are the air inlets or air outlets of indoor and outdoor units blocked?</li> <li>● Is the fan speed "LOW" or "SILENT"?</li> </ul>

### Notes



- In quiet operation or stopping the operation, the following phenomena may occasionally occur, but they are not abnormal for the operation.
  - (1) Slight flowing noise of refrigerant in the refrigerating cycle.
  - (2) Slight rubbing noise from the fan casing which is cooled and then gradually warmed as operation stops.
- The odor will possibly be emitted from the room air conditioner because the various odor, emitted by smoke, foodstuffs, cosmetics and so on, sticks to it. So the pre-filter and the evaporator regularly must be cleaned to reduce the odor.

- Please contact your sales agent immediately if the air conditioner still fails to operate normally after the above inspections. Inform your agent of the model of your unit, production number, date of installation. Please also inform him regarding the fault.
- Power supply shall be connected at the rated voltage, otherwise the unit will be broken or could not reach the specified capacity.

### NOTE:

- If the supply cord is damaged, it must be replaced by the special cord obtainable at authorized service parts centers.
- On switching on the equipment, particularly when the room light is dimmed, a slight brightness fluctuation may occur. This is of no consequence.  
The conditions of the local Power Supply Companies are to be observed.

# PREPARATION BEFORE OPERATION

## ■ To install the batteries

1. Slide the cover to take it off.
2. Install two dry batteries AAA.LR03 (alkaline).  
The direction of the batteries should match the marks in the case.
3. Replace the cover at its original position.

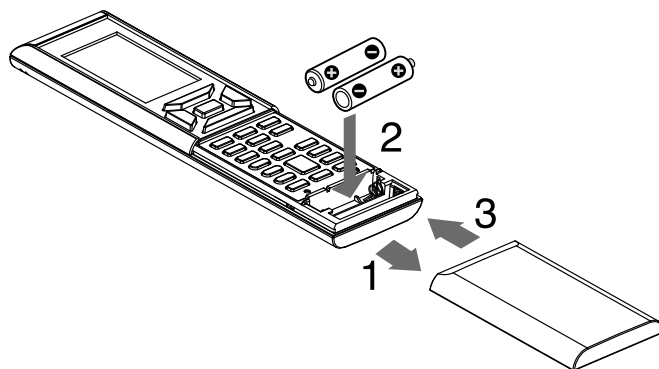

## ■ To fix the remote controller holder to the wall

1. Choose a place from where the signals can reach the unit.
2. Fix the remote controller holder to a wall, a pillar or similar location with the provided screws.
3. Place the remote controller in the remote controller holder.

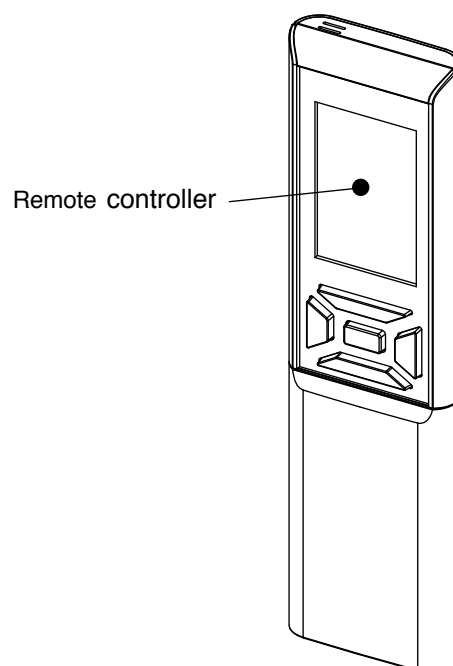

### NOTE

#### Notes on batteries

- When replacing the batteries, use batteries of the same type, and replace both old batteries together.
- When the system is not used for a long time, take the batteries out.
- The batteries will last for approximately 1 year. However, if the remote controller display begins to fade and degradation of reception performance occurs within a year, replace both batteries with new size AAA.LR03 (alkaline).
- The attached batteries are provided for the initial use of the system.  
The usable period of the batteries may be short depending on the manufactured date of the air conditioner.

#### Notes on the remote controller

- Never expose the remote controller to direct sunlight.
- Dust on the signal transmitter or receiver will reduce the sensitivity. Wipe off dust with soft cloth.
- Signal communication may be disabled if an electronic-starter-type fluorescent lamp (such as inverter-type lamps) is in the room. Consult the shop if that is the case.
- If the remote controller signals happen to operate another appliance, move that appliance to somewhere else, or consult the service shop.
- When the remote controller is not in use, please close the slide cover to prevent failure.

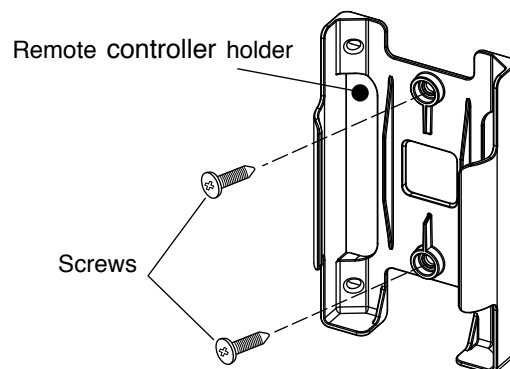

# PREPARATION BEFORE OPERATION

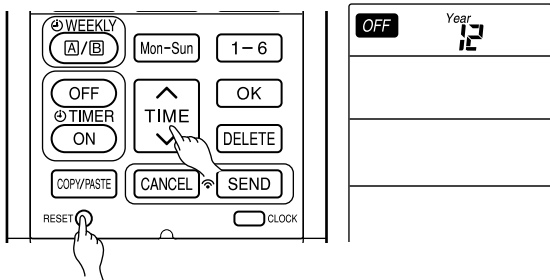

## ■ To set calendar and clock

1. Press **RESET** (RESET) button when first time setting. "Year" blinks.
  2. Press **TIME** (TIME) button to set the current year.
  3. Press **CLOCK** (CLOCK) button. "Day" and "Month" blink.
  4. Press **TIME** (TIME) button to set the current day and month.
  5. Press **CLOCK** (CLOCK) button. "CLOCK" blinks.
  6. Press **TIME** (TIME) button to set the clock to the current time.
  7. Press **CLOCK** (CLOCK) button.
- Calendar and clock are set.

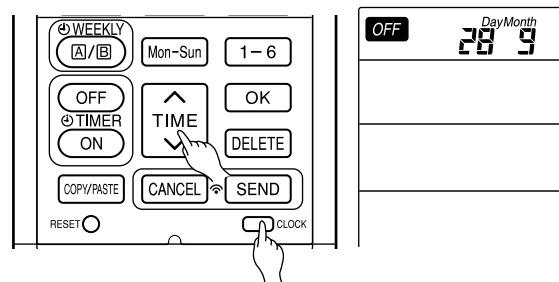

To modify the calendar and clock, press **CLOCK** (CLOCK) button.  
Then follow steps 1 to 7.

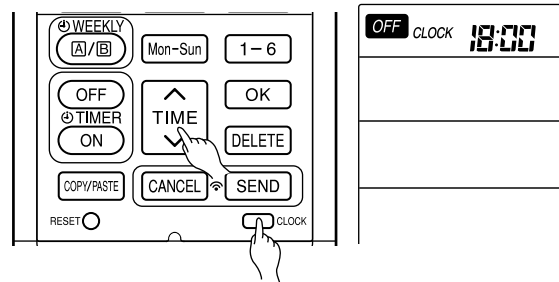

Calendar and clock need to be set again after changing batteries.

After changing the batteries,

1. Press **RESET** (RESET) button.
2. Direct remote controller towards indoor unit and press **INFO** (INFO) button.
3. The calendar and clock from indoor unit will be transmitted.

- Calendar and clock will not be transmitted from indoor unit when the following occurs:
  - When there is a power failure.
  - When breaker is OFF by user (unit is not in STANDBY MODE).

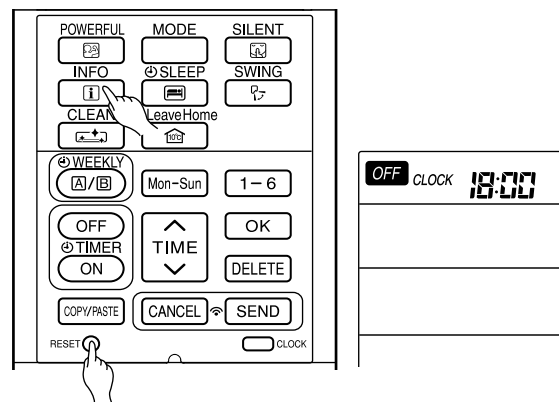

## NOTE

Note on setting the calendar and clock.

- If the calendar and clock are not set, the ON-timer, OFF-timer and Weekly Timer cannot be set.
- If the calendar and clock are not set correctly, the ON-timer, OFF-timer and Weekly Timer will not operate correctly.
- When the ON-timer, OFF-timer and Weekly Timer are set, the calendar and clock cannot be changed. If there is a need to change the calendar and clock, ON-timer, OFF-timer and Weekly Timer need to be cancelled.

# NAMES AND FUNCTIONS OF REMOTE CONTROLLER

## REMOTE CONTROLLER

- This controls the operation of the indoor unit. The range of control is about 7 meters. If indoor lighting is controlled electronically, the range of control may be shorter.  
This unit can be fixed on a wall using the fixture provided. Before fixing it, make sure the indoor unit can be controlled from the remote controller.
- Handle the remote controller with care. Dropping it or getting it wet may compromise its signal transmission capability.
- After new batteries are inserted into the remote controller, the unit will initially require approximately 10 seconds to respond to commands and operate.
- When remote controller is not in use for about 3 minutes during OFF condition, indicated by **OFF** on the display, the LCD will turn off.
- During clock setting, the LCD will turn off about 10 minutes later if the remote controller is not in use.
- When pressing any button, the LCD will turn on.
- The LCD will not turn off during TIMER setting.

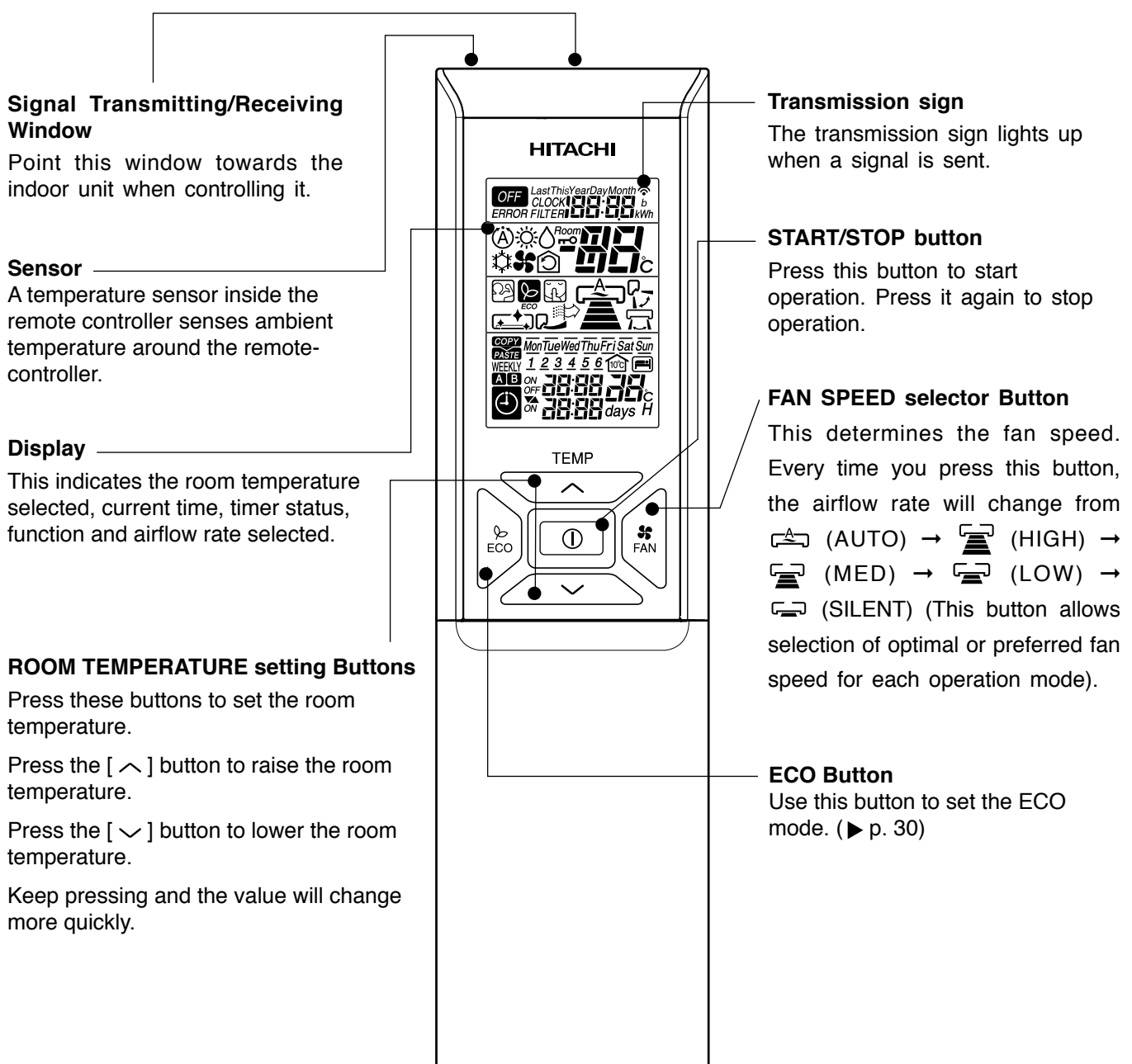

# NAMES AND FUNCTIONS OF REMOTE CONTROLLER

**POWERFUL Button**  
Use this button to set the POWERFUL mode. (▶ p. 28)

**INFORMATION Button**  
(▶ p. 42)

**ONE TOUCH CLEAN Button**  
(▶ p. 32)

**LEAVE HOME Button**  
(▶ p. 31)

**ECO SLEEP TIMER Button**  
Use this button to set the ECO sleep timer. (▶ p. 34)

**ON / OFF TIMER setting Buttons**  
(▶ p. 33)

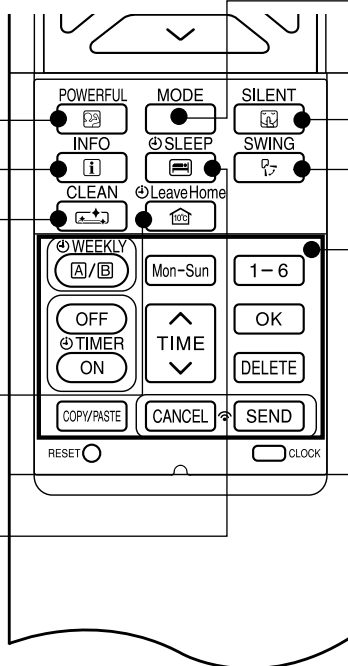

**MODE selector Button**  
Use this button to select the operating mode. Every time you press this button, the mode will change from (AUTO) → (HEAT) → (DEHUMIDIFY) → (COOL) and → (FAN) cyclically.

**SILENT Button**  
Use this button to set the SILENT mode. (▶ p. 29)

**AUTO SWING (Vertical) Button**  
Controls the angle of the horizontal air deflector. (▶ p. 27)

**WEEKLY TIMER setting Buttons**  
(▶ p. 36)

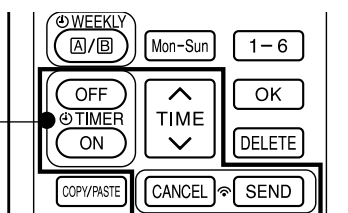

	MODE SELECTOR
	AUTO
	HEAT
	DEHUMIDIFY
	COOL
	FAN
	FAN SPEED
	AUTO SILENT
	LOW
	MED
	HIGH
	START / STOP
	ECO

	FAN
	POWERFUL
	SILENT
	INFO
	SLEEP TIMER
	AUTO SWING (VERTICAL)
	LEAVE HOME
	CLEAN
Mon-Sun	DAY
1-6	PROGRAM NO.

	ON / OFF TIMER
	TIME
	OK
	DELETE
	COPY / PASTE
	CANCEL
	SEND
	CLOCK

## Precautions for Use

- Do not put the remote controller in the following places.
  - Under direct sunlight.
  - In the vicinity of a heater.
- Handle the remote controller carefully. Do not drop it on the floor, and protect it from water.
- Once the outdoor unit stops, it will not restart for about 3 minutes (unless you turn the power switch off and on or unplug the power cord and plug it in again). This is to protect the device and does not indicate a failure.
- If you press the MODE selector button during operation, the device may stop for about 3 minutes for protection.

# VARIOUS FUNCTIONS

## Auto Restart Control

- If there is a power failure, operation will be automatically restarted when the power is resumed with previous operation mode and airflow direction.  
(As the operation is not stopped by remote controller.)
- If you intend not to continue the operation when the power is resumed, switch off the power supply.  
When you switch on the circuit breaker, the operation will be automatically restarted with previous operation mode and airflow direction.

Note: 1. If you do not require Auto Restart Control, please consult your sales agent.  
2. Auto Restart Control is not available when Timer or Sleep Timer mode is set.

## AUTOMATIC OPERATION

The device will automatically determine the mode of operation, HEAT or COOL depending on the current room temperature. The selected mode of operation will change when the room temperature varies. However, the mode of operation will not change when indoor unit is connected to multi type outdoor unit.

**1** Press the MODE selector button so that the display indicates the (AUTO) mode of operation.

- When AUTO has been selected, the device will automatically determine the mode of operation, HEAT or COOL depending on the current room temperature. However the mode of operation will not change when indoor unit is connected to multi type outdoor unit.
- If the mode automatically selected by the unit is not satisfactory, manually change the mode setting (HEAT, DEHUMIDIFY, COOL or FAN).

**2** Set the desired FAN SPEED with the (FAN SPEED) button (the display indicates the setting).

**3** Set the desired room temperature with the TEMPERATURE buttons (the display indicates the setting).  
The temperature setting and the actual room temperature may vary depending on conditions.

**START STOP** Press the (START/STOP) button.  
Operation starts with a beep.  
Press the button again to stop operation.

- As the settings are stored in the memory of the remote controller, you only have to press the (START/STOP) button next time.

Press the (FAN SPEED) button to select AUTO, HIGH, MED, LOW or SILENT.



# HEATING OPERATION

- Use the device for heating when the outdoor temperature is under 21°C. When it is too warm (over 21°C), the heating function may not work in order to protect the device.
- In order to maintain reliability of the device, please use this device when outdoor temperature is above -15°C.

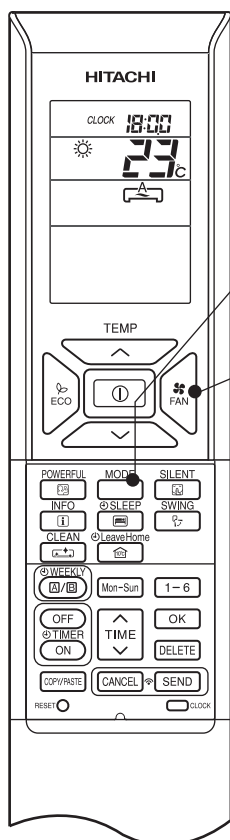

**1**

Press the MODE selector button so that the display indicates  (HEAT).

**2**

Set the desired FAN SPEED with the  (FAN SPEED) button (the display indicates the setting).

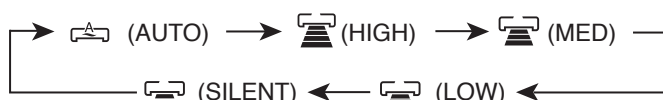



**3**

Set the desired room temperature with the TEMPERATURE buttons (the display indicates the setting).

The temperature setting and the actual room temperature may vary depending on conditions.

**START STOP**

Press the  (START/STOP) button. Heating operation starts with a beep. Press the button again to stop operation.

- As the settings are stored in the memory of the remote controller, you only have to press the  (START/STOP) button next time.
- During AUTO fan, the fan speed automatically changes as below:
  - When the difference between room temperature and setting temperature is large, fan starts to run at HI speed.
  - After room temperature reaches the preset temperature, fan speed will be changed to lower speed to obtain optimum room temperature condition for natural healthy heating.

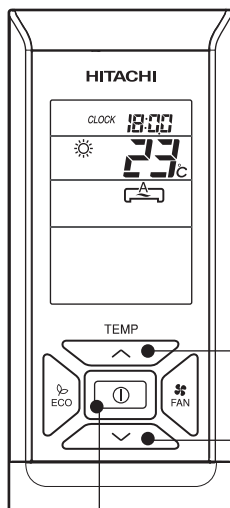

## Defrosting

Defrosting will be performed about once an hour when frost forms on the heat exchange of the outdoor unit, for 5~10 minutes each time.

During defrosting operation, the operation lamp blinks in a cycle of 3 seconds on and 0.5 second off.

The maximum time for defrosting is 20 minutes.

However, if the indoor unit is connected to multi type outdoor unit, the maximum time for defrosting is 15 minutes.



(If the piping length used is longer than usual, frost is likely to form.)

# DEHUMIDIFYING OPERATION

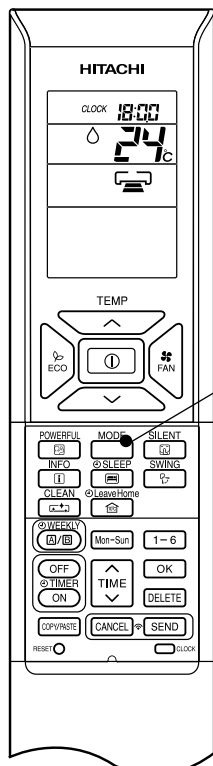
Use the device for dehumidifying when the room temperature is over 16°C.  
When it is under 15°C, the dehumidifying function will not work.



1

Press the MODE selector button so that the display indicates  (DEHUMIDIFY).  
The fan speed is set at LOW.  
Press  (FAN SPEED) button to select SILENT or LOW fan speed.

2

Set the desired room temperature with the ROOM TEMPERATURE setting buttons (the display indicates the setting).

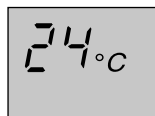

The range of 20-26°C is recommended as the room temperature for dehumidifying.

START  
STOP

Press the  (START/STOP) button. Dehumidifying operation starts with a beep. Press the button again to stop operation.

- As the settings are stored in the memory of the remote controller, you only have to press the  (START/STOP) button next time.

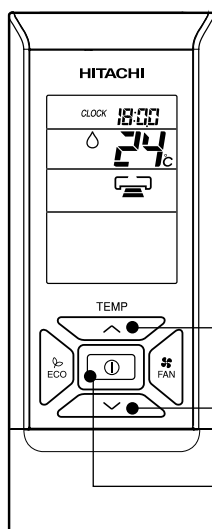

## ■ Dehumidifying Function

- When the room temperature is higher than the temperature setting: The device will dehumidify the room, reducing the room temperature to the preset level.  
When the room temperature is lower than the temperature setting: Dehumidifying will be performed at the temperature setting slightly lower than the current room temperature, regardless of the temperature setting.
- The preset room temperature may not be reached depending on the number of people present in the room or other room conditions.

# COOLING OPERATION

Use the device for cooling when the outdoor temperature is -10~43°C.  
If indoors humidity is very high (80%), some dew may form on the air outlet grille of the indoor unit.

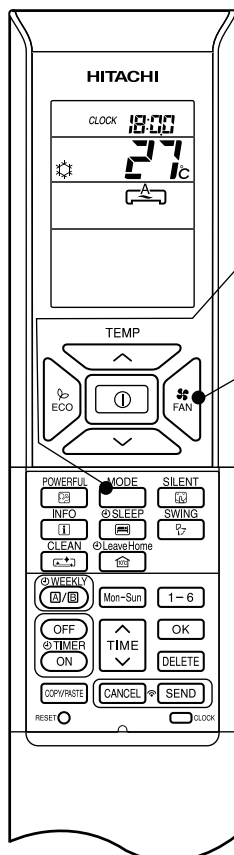

**1**

Press the MODE selector button so that the display indicates  (COOL).

**2**

Set the desired FAN SPEED with the  (FAN SPEED) button (the display indicates the setting).

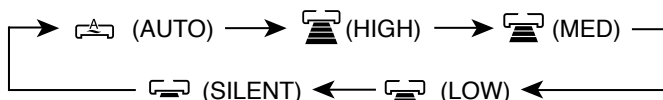



**3**

Set the desired room temperature with the TEMPERATURE buttons (the display indicates the setting).

The temperature setting and the actual room temperature may vary depending on conditions.

**START  
STOP**

Press the  (START/STOP) button. Cooling operation starts with a beep. Press the button again to stop operation. The cooling function does not start if the temperature setting is higher than the current room temperature (even though the  (OPERATION) lamp lights). The cooling function will start as soon as user set the temperature below the current room temperature.

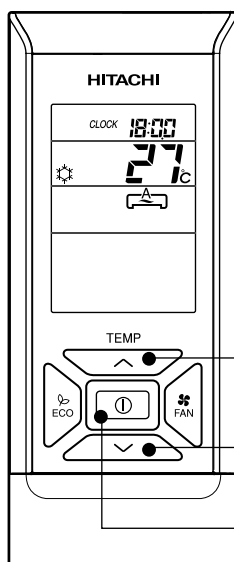







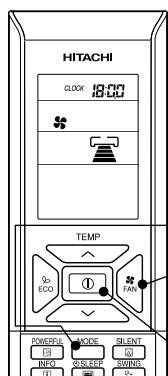

- As the settings are stored in the memory of the remote controller, you only have to press the  (START/STOP) button next time.
- During AUTO fan, the fan speed automatically changes as below:
  - When the difference between room temperature and setting temperature is large, fan starts to run at HI speed.
  - After room temperature reaches the preset temperature, fan speed will be changed to lower speed to obtain optimum room temperature condition for natural healthy cooling.

# FAN OPERATION

User can use the device simply as an air circulator.





- 1** Press the MODE selector so that the display indicates  (FAN).
- 2** Set the desired FAN SPEED with the  (FAN SPEED) button (the display indicates the setting).  
  (HIGH) →  (MED) →  (LOW) →  (SILENT) →
- START STOP** Press the  (START/STOP) button. Fan operation starts with a beep. Press the button again to stop operation.



# AUTO SWING OPERATION

## VERTICAL SWING

### ■ To start Vertical Auto Swing

- Press  (AUTO SWING (VERTICAL)) button. The deflector(s) will start to swing up and down.  
 is displayed on the LCD.

### ■ To cancel Vertical Auto Swing

- Press  (AUTO SWING (VERTICAL)) button again. The deflector(s) will stop in the current position.  
 disappeared from the LCD.

## NOTE

- During cooling and dehumidifying operation, do not keep the deflectors swinging or in the lower position (in the case of vertical auto swing) for a long time. It may cause dew condensation on the deflectors.



# POWERFUL OPERATION

- By pressing  (POWERFUL) button during AUTO, HEATING, DEHUMIDIFYING, COOLING or FAN operation, the air conditioner performs at the maximum power.
- During POWERFUL operation, cooler or warmer air will be blown out from indoor unit for COOLING or HEATING operation respectively.

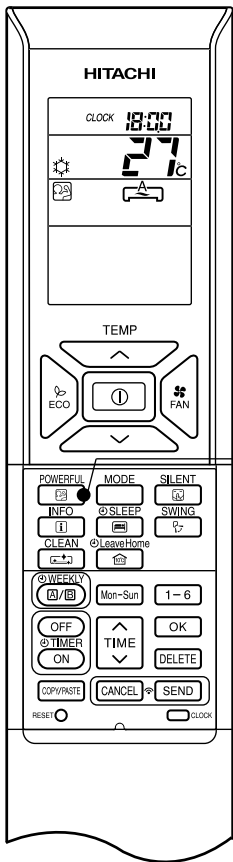



## ■ To start POWERFUL operation

- Press  (POWERFUL) button during operation.

“” is displayed on the LCD.

POWERFUL operation ends in 20 minutes. Then the system automatically operates with the previous settings used before POWERFUL operation.

## ■ To cancel POWERFUL operation

- Press the  (START/STOP) button. Or
- Press  (POWERFUL) button again.

POWERFUL operation stops.

“” disappears from the LCD.

## NOTE



- When SLEEP mode, ECO mode, SILENT mode or LEAVE HOME mode is selected, POWERFUL operation is cancelled.
- During POWERFUL operation, capacity of the air conditioner will not increase
  - if the air conditioner is already running at maximum capacity.
  - just before defrost operation (when the air conditioner is running in HEATING operation).
- After auto restart, POWERFUL operation is cancelled and previous operation shall start.
- For multi model connections, POWERFUL operation may not function depending on operation conditions.

## SILENT OPERATION

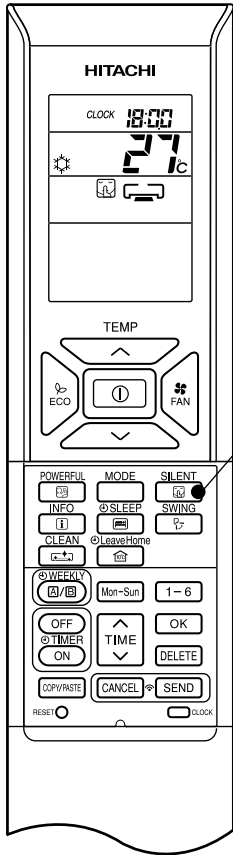



- By pressing  (SILENT) button during AUTO, HEATING, DEHUMIDIFYING, COOLING or FAN operation, the fan speed will change to ultra slow.





### ■ To start SILENT operation

- 1 ● Press  (SILENT) button during operation.  
“” is displayed on the LCD. Fan speed will be ultra slow.

### ■ To cancel SILENT operation

- Press  (START/STOP) button. Or
- Press  (SILENT) button again or  (FAN SPEED) button.  
Fan speed will return to previous fan speed before SILENT operation starts.  
SILENT operation stops.  
“” disappears from the LCD.

### NOTE

- When POWERFUL operation is selected, SILENT operation is cancelled. Fan speed will return to previous fan speed before SILENT operation.
- After auto restart, SILENT operation is cancelled. Fan speed will return to previous fan speed before SILENT operation.
- During any operation with fan speed  (SILENT), if press  (SILENT) button, fan speed will not change.



# ECO OPERATION

ECO operation is an energy saving function by changing set temperature automatically and by limiting the maximum power consumption value.

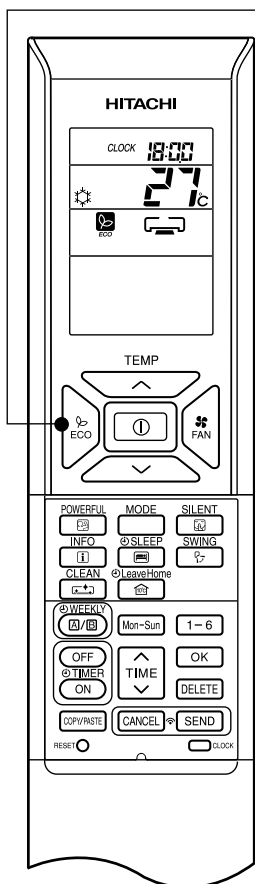

1

- By pressing the  (ECO) button during AUTO, HEATING, DEHUMIDIFYING or COOLING operation, the air conditioner performs the "ECO" operation.



## ■ To start ECO operation

- Press  (ECO) button during operation.

“” is displayed on the LCD.

Energy saving operation will start by changing the set temperature higher or lower automatically and reducing operation power consumption. This function may vary based on the connected outdoor unit.

## ■ To cancel ECO operation

- Press  (START/STOP) button. Or
- Press  (ECO) button again.

“” disappears from the LCD.

## NOTE

- ECO function will not be effective when power consumption is low.
- By pressing (POWERFUL) button, ECO operation is cancelled.
- After auto restart, ECO operation is cancelled and previous operation mode shall start.
- For multi model connections, energy saving operation shall start only by changing set temperature higher or lower automatically. However, effectiveness of ECO depends on operation conditions.

# 10°C LEAVE HOME(LH) OPERATION

Prevent the room temperature from falling too much by setting temperature 10°C automatically when no one is at home. This operation is able to operate by "Continuous operation" or "Day timer operation". Please use "Day timer operation" to set the number of days up to 99 days.

## Continuous operation

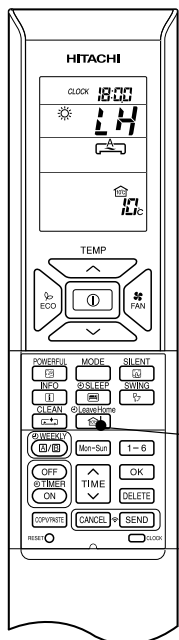

## Day timer operation

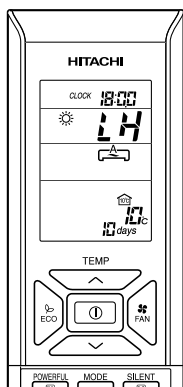

## To start LEAVE HOME operation

### Option 1. Continuous operation.

- Press (LEAVE HOME) button during stop or operation. Room temperature is set at 10°C and heating operation starts. "☀", "LH", "🏠", "10c" is displayed on the LCD.

### Option 2. Day timer operation.

- Press (LEAVE HOME) button during stop or operation. Room temperature is set at 10°C and heating operation starts. "☀", "LH", "🏠", "10c" is displayed on the LCD.

- Set number of operation days (1 to 99 days), if needed.

Press (TIME) button to select number of days.

Number of days blink.

- \* Press " ^ (UP)" to set number of days from 1 day, 2 days, 3 days ..... 98 days, 99 days, 1 day and so on.
- \* Press " v (DOWN)" to set number of days from 99 days, 98 days, 97 days .... 3 days, 2 days, 1 day, 99 days and so on.
- \* Number of day is counted when clock indicates 0:00.

- Press (SEND) button to confirm number of operation days. Display for number of operation days will stop blinking.
- Press (CANCEL) button to reset number of operation days or to have continuous operation.

## To cancel LEAVE HOME operation

- Press (START/STOP) button. Or
- Press (LEAVE HOME) button again. Return to previous operation mode. Or
- Change to other operation mode by pressing (MODE) button.

## NOTE

- After reaching the set number of operation days for Leave Home or by pressing the (Leave Home) button again, the unit will operate in previous mode.
- During Leave Home operation, fan speed and horizontal air deflector position cannot be changed.
- By pressing (Leave Home) button, implementation of Weekly Timer or Once Timer is cancelled.
- In case of power supply shut down, after autorestart, all setting for number of days operation will be reset and unit shall be in continuous operation.
- For multi connections, when each room is running in different operation modes such as FAN only, COOLING, DEHUMIDIFYING or AUTO mode, Leave Home operation cannot operate even though it is possible to set Leave Home operation. In order to start Leave Home operation, all rooms must stop its operation. Then, press (LEAVE HOME) button to operate Leave Home operation.
- For multi connections, when all rooms are running HEATING operation, it is possible to operate Leave Home operation by pressing the (LEAVE HOME) button.
- For multi connections, if two or more rooms are set to operate Leave Home operation, the capability to reach the set temperature at 10°C may not possible. In addition, this also depends on outdoor temperature.
- POWERFUL, SILENT and ECO operations are not applicable during Leave Home operation.



## CLEAN (ONE TOUCH CLEAN) OPERATION

Drying indoor heat exchanger after cooling operation to prevent mildew.

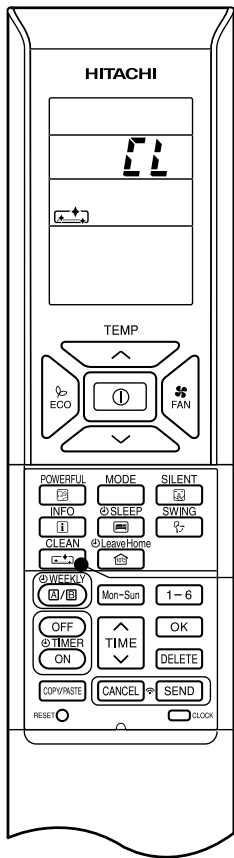



### ■ To start CLEAN operation

- Press  (CLEAN) button when unit is OFF.  
Total time taken for One Touch Clean operation is 60 minutes.  
During this operation, HEATING or FAN operation shall operate.  
During one touch clean, operation lamp is blinking.

“”, “” is displayed on the LCD.

### ■ To cancel CLEAN operation

- Press  (START/STOP) button. Or
- Press  (CLEAN) button again.

### NOTE

- When CLEAN operation finish, unit will switch OFF automatically.
- If Weekly Timer or Once Timer is set, there is a need to cancel those timer before operating CLEAN function.
- For multi connections, when pressing  (CLEAN) button, operation is limited to FAN operation.
- For multi connections, when one room operates CLEAN operation first, other rooms can operate COOLING, DEHUMIDIFYING or FAN operation. However, when other rooms need to operate HEATING operation, air conditioner will be in STANDBY mode. After CLEAN operation finish, HEATING operation will start.



# ONCE TIMER (ON/OFF TIMER) OPERATION

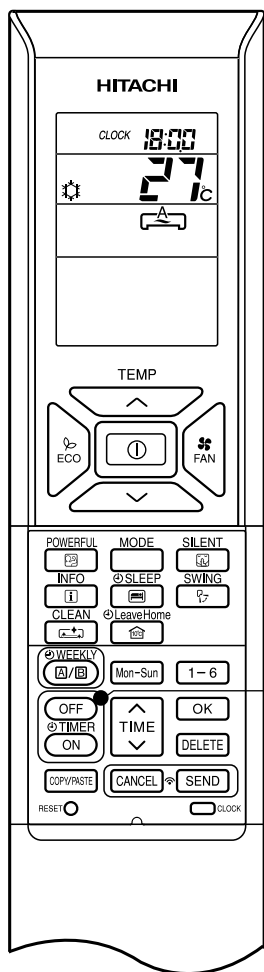

## OFF TIMER

The device can be set to turn off at a preset time.

1. Press (OFF-TIMER) button. and blink on the display.
2. Set the "turn-off time" with (TIME) button.
3. After setting, direct the remote controller towards the indoor and press (SEND) button.  
 and "set time" lights up instead of blinking.

A beep sound emitted from indoor unit and the (TIMER) lamp on the indoor unit lights up.

## ON TIMER

The device will turn on at a designated time.

1. Press (ON-TIMER) button. and blink on the display.
2. Set the "turn-on time" with (TIME) button.
3. After setting, direct the remote controller towards the indoor and press (SEND) button.  
 and "set time" light up instead of blinking.

A beep sound emitted from indoor unit and the (TIMER) lamp on the indoor unit lights up.

## ON/OFF TIMER

- The device will turn on (off) and off (on) at the designated time.
- The switching occurs first at the preset time that comes earlier.
- The arrow mark appears on the display to indicate the sequence of switching operations.

1. Press (OFF-TIMER) button so that and blink on the display.
2. Set the "turn-off" time with (TIME) button. After setting, direct the remote controller towards the indoor and press (SEND) button.
3. Press (ON-TIMER) button so that and set "turn-off" time light up. The and blink.
4. Set the "turn-on" time with (TIME) button.
5. After setting, direct the remote controller towards the indoor and press (SEND) button  
 and set "turn-on" time light up instead of blinking.

A beep sound emitted from indoor unit and the (TIMER) lamp on the indoor unit lights up.

- The timer may be used in three ways: OFF-timer, ON-timer and ON/OFF (OFF/ON)-timer. Set the current time first because it serves as a reference.

## ■ To cancel Reservation

- Point the signal window of the remote controller towards the indoor unit and press (CANCEL) button.  
 and "ON or OFF set time" goes out with a beep and the (TIMER) lamp on the indoor unit turns off.

## NOTE

- User can set only one of the OFF-timer, ON-timer or ON/OFF-timer.
- If WEEKLY TIMER already set, by setting the ONCE TIMER, ONCE TIMER operation is prioritized. When ONCE TIMER operation is complete, WEEKLY TIMER operation will be activated.



## ECO SLEEP TIMER OPERATION

The timer can be set up to a duration of 7 hours.

By pressing (SLEEP) button during AUTO, HEATING, DEHUMIDIFYING, COOLING or FAN operation, the unit shifts the room temperature and reduces the fan speed. It results in energy saving.

Set the current time first before operating the ECO SLEEP TIMER operation.

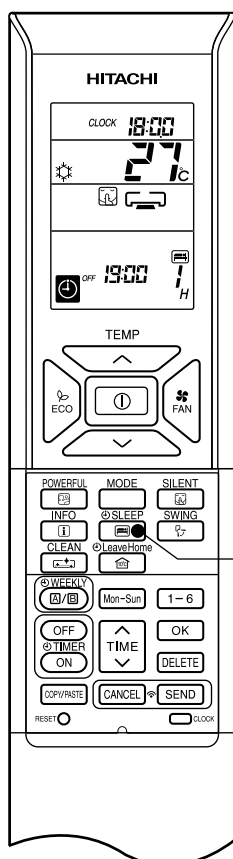

### To start ECO SLEEP TIMER operation

Press (SLEEP) button during operation.

- “”, “”, “”, “OFF”, off time, “” and number of hour are displayed on the remote controller display.
- During ECO SLEEP TIMER operation, fan speed will be ultra slow.
- A beep sound emitted from indoor unit and the (TIMER) lamp on the indoor unit lights up.

Pressing (SLEEP) button repeatedly, the number of hours will change as below:

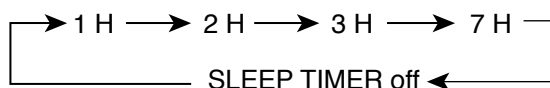

- During ECO SLEEP TIMER operation, air conditioner will continue to operate for the designated number of hours and then turn off.
- When the ECO SLEEP TIMER has been set, the display on the remote controller indicates the turn off time.



Example: If ECO SLEEP TIMER is set for 1 hour at 18:00, the switch off time will be at 19:00.

### To cancel ECO SLEEP TIMER operation

Press (START/STOP) button.

- Room air conditioner will switch off.

Press (SLEEP) button again until “”, “”, “”, off time, “” and number of hour disappear from the remote controller display.

Press (CANCEL) button.

- A beep sound emitted from indoor unit and the (TIMER) lamp on the indoor unit turns off.
- SLEEP TIMER operation is cancelled.



## ECO SLEEP TIMER OPERATION

### To set ECO SLEEP TIMER and ON TIMER

The air conditioner will be turned off by ECO SLEEP TIMER and turned on by ON TIMER.

1. Set the ON TIMER.
2. Press (SLEEP) button and set ECO SLEEP TIMER.



Example:

In this case, air conditioner will turn off in 2 hours (at 1:38) and it will be turned on at 6:00 the next morning.

### To cancel ECO SLEEP TIMER and ON TIMER operation

Direct the remote controller towards the indoor unit and press (CANCEL) button.

- “”, “”, “”, “OFF”, off time, “”, number of hour, "ON" and ON TIMER set time disappear from the remote controller display.
- A beep sound emitted from indoor unit and the (TIMER) lamp on the indoor unit turns off.
- ECO SLEEP TIMER and ON TIMER reservations are cancelled.

30 minutes after setting ECO SLEEP TIMER, outdoor fan speed will be reduced to lower the noise level and to have comfort operation.

1 hour after setting ECO SLEEP TIMER, set temperature will be slightly shifted. Amount of temperature shifted depends on type of air conditioner.

These automatic operation changes contribute to energy saving without losing comfort.

The level of energy consumption depends on outside temperature, room temperature, set temperature or air conditioner type.

Cooling operation [diagram representation for illustrative purpose only]

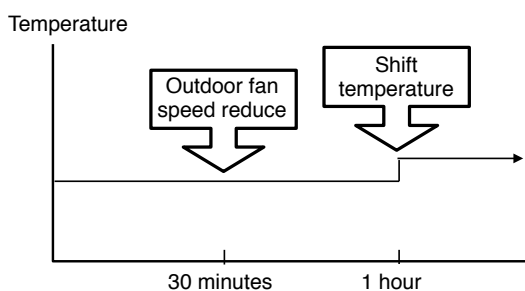

Heating operation [diagram representation for illustrative purpose only]

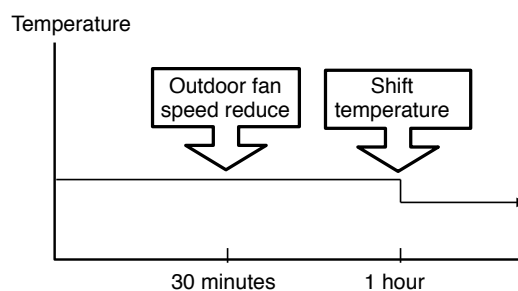

#### NOTE

- If ECO SLEEP TIMER is set when OFF TIMER or ON/OFF TIMER has been set earlier, the ECO SLEEP TIMER becomes effective instead of the OFF TIMER or ON/OFF TIMER.



# WEEKLY TIMER OPERATION

- It is possible to select Mode A or Mode B. For each mode, up to 6 programs can be set per day. In total, a maximum of 42 programs can be set for a week for each mode.
- If calendar and clock are not set, the reservation setting for WEEKLY TIMER cannot be set.
- If calendar and clock are not set correctly, WEEKLY TIMER will not operate correctly.
- Reservation for calendar and clock shall be set first before operating WEEKLY TIMER.

**Step 1: Set the reservation schedule to the remote controller. Send the registered reservation to indoor unit and then operate.**

**Step 2: Select Mode A or Mode B and activate or deactivate WEEKLY TIMER .**

**Step 3: Copy and cancel the reservation schedule.**

## Step 1 : Set reservation schedule to the remote controller. Send the registered reservation to indoor unit and then operate.

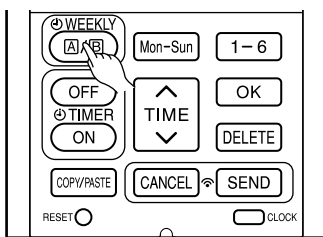

1

2

### How to set a WEEKLY TIMER.

#### 1. Select Mode A or Mode B

Press (WEEKLY) button. WEEKLY lights up. **A** and blink on the display. (Mode A is selected).

Press (WEEKLY) button again, **B** and blink on the display. (Mode B is selected).

- If no reservation has been made, ON/OFF, --:-- , appear.
- If reservation has been made, ON/OFF, --:-- , will not appear.

#### 2. Set a program

Press (WEEKLY) button for about 3 seconds. The selection mode can be changed.

, day: Mon, program no. : 1, ON/OFF, setting time and setting temperature blink on the display.

#### 3. Select the desired day of the week

Press (DAY) button.

The day changes from Mon → Tue → Wed → Thu → Fri → Sat → Sun → Mon, Tue, Wed, Thu, Fri, Sat, Sun [Full days] → Mon, Tue, Wed, Thu, Fri [weekday] → Sat, Sun [weekend] → Mon → Tue .....

Select [Full days] for daily reservation.

Select [weekday] for Monday to Friday reservation.

Select [weekend] for Saturday and Sunday reservation.

- After reservation has been set, it is easy to check and edit at the same time.

#### 4. Press button to select a program number.

The number changes from 1 → 2 → 3 → 4 → 5 → 6 → 1 → 2 .....

- If program number has been set, follow above in order to make changes.

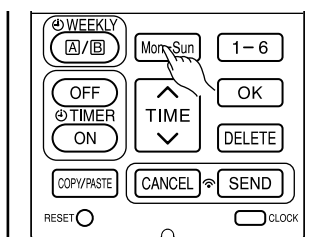

3

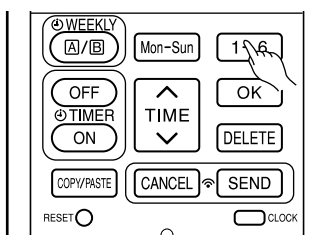

4



# WEEKLY TIMER OPERATION

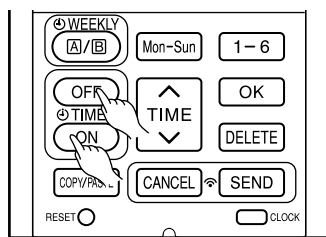

5

5. Press (ON-OFF TIMER) button to select ON TIMER or OFF TIMER reservation.

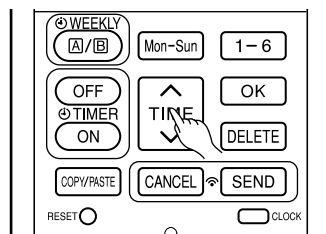

6

6. Press (TIME) button to set time reservation.

7. Press (TEMP ^ or v) button to set temperature reservation.

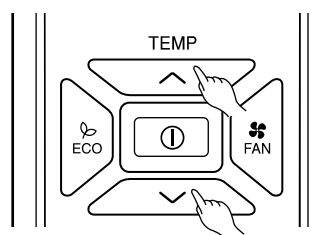

7

8. Press (OK) button. The reservations are set. Day, program number, ON reservation, setting temperature will light up. will be continuously blinks. If reservation is not complete, settings will not be stored in memory.

To continue with the reservation, press buttons. Follow step 3 to 8 for reservation.

9. After all the reservations have been set, press (SEND) button while directing the remote controller towards the indoor unit for about 3 seconds. Timer lamp on the indoor unit will blink rapidly.

After beep sound emitted from indoor unit, TIMER lamp will light up.

**Please ensure that the TIMER lamp lights up.**

This indicates that the reservation has been stored in the indoor unit and Timer function has been completed.

The reservation contents will appear on the remote controller display.

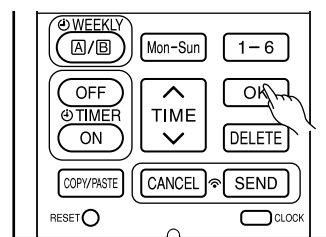

8

- If TIMER lamp on the indoor unit does not light up, press (SEND) button while directing the remote controller towards the indoor unit for about 3 seconds.

- **CAUTION !** Do not press (CANCEL) button during reservation setting because this will result in all reservation contents to be lost.

- The reservation contents will not stored in the indoor unit until (SEND) button has been pressed.

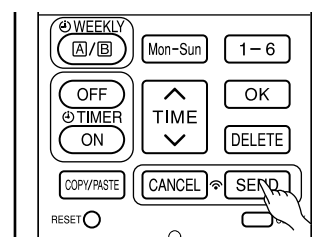

9

## NOTE

- Up to 6 programs can be set per day. Setting ON TIMER or OFF TIMER for each program number can be at random. When pressing (SEND) button, the set ON TIMER or OFF TIMER for each program number will automatically arranged so that program number 1 shall have the earliest time and program number 6 shall have the latest time.

If the setting time is the same, Priority will be given to the latest reservation contents.

- **CAUTION !** If the remote controller is left idle and (SEND) button is not pressed within 3 minutes after reservations have been made , all current reservations will be lost.



## WEEKLY TIMER OPERATION

### Step 2: Select Mode A or Mode B and activate or deactivate WEEKLY TIMER.

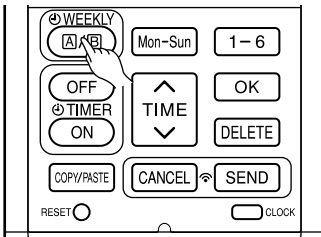

1

#### ■ How to select Mode A or Mode B of WEEKLY TIMER setting.

1. Press (WEEKLY) button. **A** and blink on the display. (Normally Mode A will blink first).
2. Press (WEEKLY) button again. **B** and blink on the display.
3. Select Mode A or Mode B. Press (SEND) button while directing the remote controller towards the indoor unit for about 3 seconds. Timer lamp on the indoor unit will blink rapidly.

2

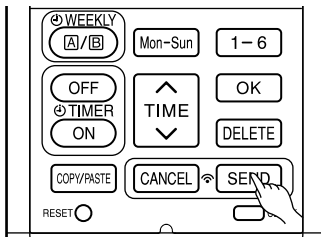

3

After beep sound emitted from indoor unit, TIMER lamp will light up.

**Please ensure that the TIMER lamp lights up.**

This indicates that Mode A or Mode B selection and active WEEKLY TIMER have been confirmed.

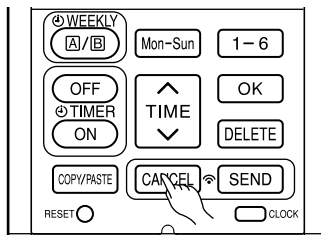

1

#### ■ Setting non-active WEEKLY TIMER .

1. Direct the remote controller towards the indoor unit and press (CANCEL) button.  
Beep sound will be emitted from indoor unit and TIMER lamp will be OFF. Reservation indication on remote display will also disappear.  
This indicates that non-active WEEKLY TIMER has been confirmed.
- To activate back the setting of WEEKLY TIMER , repeat the steps for "How to select Mode A or Mode B of WEEKLY TIMER setting".

#### NOTE

- When setting ONCE TIMER, operation of WEEKLY TIMER is interrupted. After ONCE TIMER operation is complete, WEEKLY TIMER operation will be activated.
- When ONCE TIMER is cancelled, operation of WEEKLY TIMER is also cancelled. Need to set WEEKLY TIMER operation for activation.
- After auto restart, WEEKLY TIMER operation is cancelled. Need to set WEEKLY TIMER operation for activation.



# WEEKLY TIMER OPERATION

## Step 3: Copy and cancel the reservation schedule.

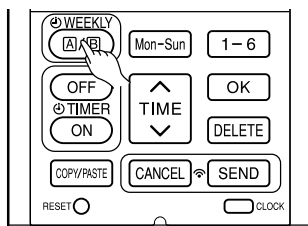

1

### ■ How to copy and paste.

Editing the reservation schedule is easy by copying data from one day to another day.

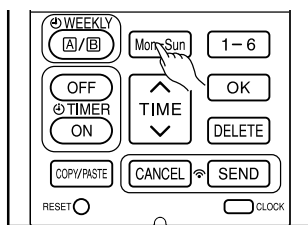

2

1. Press **WEEKLY (A/B)** (WEEKLY) button to select Mode A or Mode B.

2. Press **WEEKLY (A/B)** (WEEKLY) button for about 3 seconds to start editing the reservation schedule.

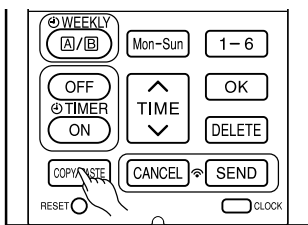

3

3. Press **Mon-Sun** (DAY) button to select a day of the week to copy.

4. Press **COPY/PASTE** (COPY/PASTE) button. Then "PASTE" blinks on the display.  
\* Press **CANCEL** (CANCEL) button to cancel the COPY mode. Normal setting mode is activated.

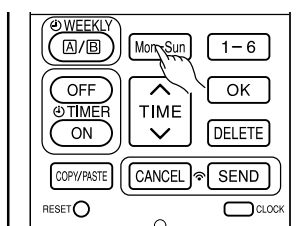

4

5. Press **Mon-Sun** (DAY) button to select a day of the week to paste.

6. Press **COPY/PASTE** (COPY/PASTE) button one more time to paste.  only blinks on the display.

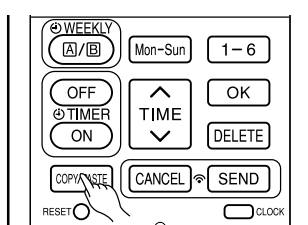

5

7. To continue copying to other days, press **Mon-Sun** or **1-6** or **TIME** or



Then start from step 3.

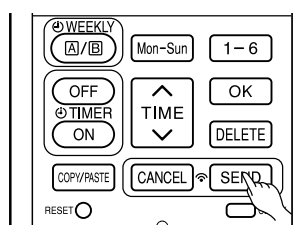

6

8. After copy and paste completed, press **SEND** (SEND) button while directing the remote controller towards the indoor unit for about 3 seconds. Timer lamp on the indoor unit will blink rapidly.

After beep sound emitted from indoor unit, **TIMER** lamp will light up.

**Please ensure that the TIMER lamp lights up.**

If **TIMER** lamp does not light up, Press **SEND** (SEND) button again.

8

● Reservation data will not change if **SEND** (SEND) button is not pressed.

### NOTE

- If there is no reservation data, copying data from one day to another day cannot be done.



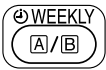

# WEEKLY TIMER OPERATION

## Step 3: Copy and cancel the reservation schedule.

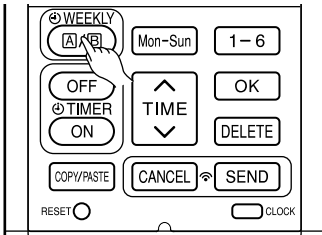

1

### ■ How to delete WEEKLY TIMER data.

[Delete one program number reservation]

2

1. Press (WEEKLY) button to select Mode A or Mode B.
2. Press (WEEKLY) button for 3 seconds to start editing the reservation schedule.

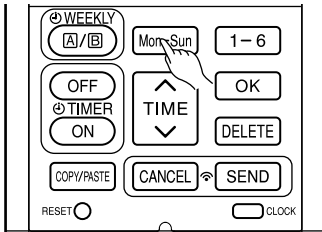

3

3. Press (DAY) button to select a day of the week to edit.
4. Press to select program number. Selected program number will blink.
5. Press (DELETE) button. Reservation of selected program number is deleted.

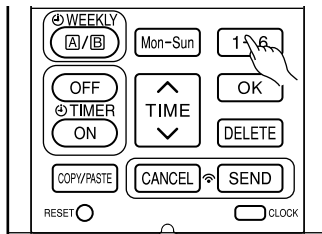

4

6. After deleting, press (SEND) button while directing the remote controller towards the indoor unit for about 3 seconds. Timer lamp on the indoor unit will blink rapidly.  
After beep sound emitted from indoor unit, TIMER lamp will light up.

**Please ensure that the TIMER lamp lights up.**

- Reservation will not change if (SEND) button is not pressed.

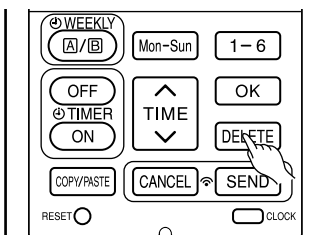

5

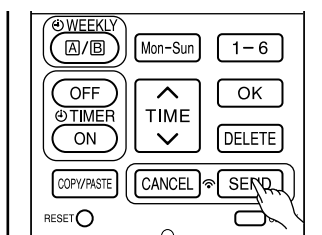

6



# WEEKLY TIMER OPERATION

## Step 3: Copy and cancel the reservation schedule.

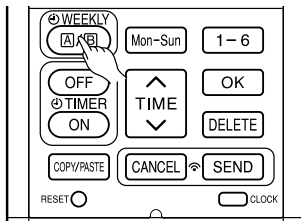

1

[Delete one day reservation]

1. Press **WEEKLY (A/B)** (WEEKLY) button to select Mode A or Mode B.

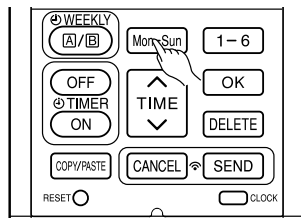

2

2. Press **WEEKLY (A/B)** (WEEKLY) button for 3 seconds to start editing the reservation schedule.

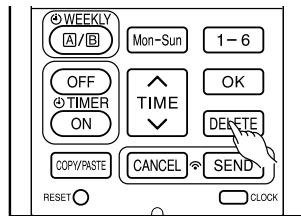

3

3. Press **Mon-Sun** (DAY) button to select a day of the week to edit.

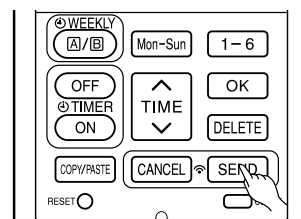

4

4. Press **DELETE** (DELETE) button for about 10 seconds. Reservations for all program numbers will be deleted.

- If press for a short time, reservation for one program number will be deleted.

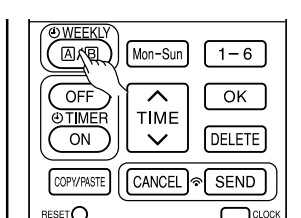

5

5. After deleting, press **SEND** (SEND) button while directing the remote controller towards the indoor unit for about 3 seconds. Timer lamp on the indoor unit will blink rapidly.

After beep sound emitted from indoor unit, TIMER lamp will light up.

**Please ensure that the TIMER lamp lights up.**

- Reservation will not change if **SEND** (SEND) button is not pressed.

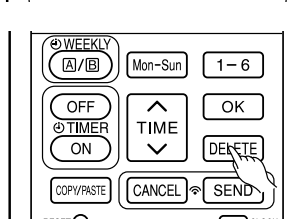

1

[Delete Mode A or Mode B]

1. Press **WEEKLY (A/B)** (WEEKLY) button to select Mode A or Mode B.

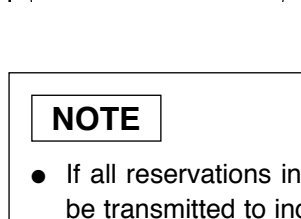



2

2. Direct the remote controller towards the indoor unit and press **DELETE** (DELETE) button for about 10 seconds while Mode A or Mode B display blinks.

After beep sound emitted from indoor unit, reservations for Mode A or Mode B will disappear.

### NOTE

- If all reservations in the remote controller were deleted and pressed **SEND** (SEND) button, no signal will be transmitted to indoor unit. TIMER lamp will remain off and no changes will be done to the reservations stored in the indoor unit.

- By pressing  (INFO) button, temperature around remote controller and monthly power consumption will be displayed on the remote controller.
- After changing the batteries, direct the remote controller towards the indoor unit and press  (INFO) button. Current calendar and clock will be transmitted from indoor unit.
- In order to receive information from indoor unit, the distance between remote controller and receiver of indoor units is within 2 meters.

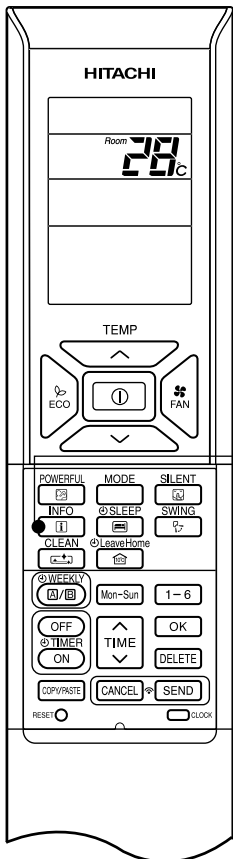

### ■ To check temperature around remote controller

1

Press  (INFO) button.

Temperature will be displayed for 10 seconds.

### ■ To check monthly power consumption

Direct the remote controller towards the receiver of indoor unit (within 2 meters in front of indoor unit) and press  (INFO) button. Wait for 2 seconds for signal transmission.

While temperature around remote controller is displayed, press  (INFO) button repeatedly. The display will show as below:

this month power consumption amount for heating → last month power consumption amount for heating → this month power consumption amount for cooling → last month power consumption amount for cooling → temperature around remote controller → this month power consumption amount for heating ..... cyclically.

- If indication is not given, bring remote controller closer to the receiver of the indoor unit.
- Indicated value shall be regarded as a guide only.



### ■ Current calendar and clock can be retrieved from indoor unit

Direct the remote controller towards the receiver of indoor unit (within 2 meters in front of indoor unit) and press  (INFO) button. Wait for 2 seconds for signal transmission.

Once received the current calendar and clock, check whether they are correct or not by pressing  (CLOCK) button.

- If there is no power supply to indoor unit or calendar and clock have not been set, INFO function cannot be used for sending or receiving information.

### NOTE

- In case failure occurs to the air conditioner, by pressing  (INFO) button, an error code will be displayed. Direct the remote controller towards the receiver of indoor unit (within 2 meters in front of indoor unit) and press  (INFO) button. Wait for 2 seconds for signal transmission. An error code will be displayed. Call service center and inform the error code.
- Information of "Monthly power consumption" are not available for model RAM-130NP6A.
- Info Function to check monthly power consumption. During installation, in case of power failure or breaker ON / OFF, ensure to set the clock and calendar for each indoor unit (unit in standby mode or auto restart), for single or multi connection, by pressing  (START / STOP) button. Failure to do the above, monthly power consumption amount will not be displayed on the remote controller.

# OPERATION MODE LOCK

The remote controller can be set to fix the HEATING mode (including FAN), COOLING mode (including FAN) and DEHUMIDIFYING mode (including FAN) operations.

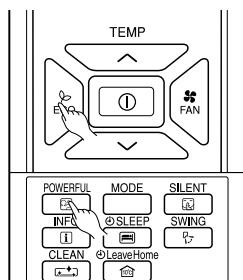

## ■ Method to lock HEATING mode (including FAN) operation.

Press (ECO) and (POWERFUL) buttons simultaneously for about 5 seconds when the remote controller is OFF.

“”, “” and “” will be displayed for about 10 seconds. Later, “” and “” will remain.

This indicates that HEATING mode operation is locked.

When pressing (MODE) button, “” or “” will be displayed.

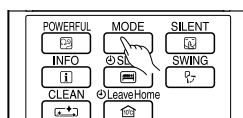

## ■ Method to unlock HEATING mode (including FAN) operation.

Press (ECO) and (POWERFUL) buttons simultaneously for about 5 seconds when the remote controller is OFF.

All operation mode symbols will appear on the display for about 10 seconds. After that, operation mode symbol before cancellation will be displayed.

This indicates that HEATING mode operation is unlocked.

## ■ Method to lock COOLING and DEHUMIDIFYING modes (including FAN) operations.

Press (ECO) and (SILENT) buttons simultaneously for about 5 seconds when the remote controller is OFF.

“”, “”, “” and “” will be displayed for about 10 seconds. Later, “” and “” will remain.

This indicates that COOLING and DEHUMIDIFYING mode operation is locked.

When pressing (MODE) button, “”, “” or “” will be displayed.

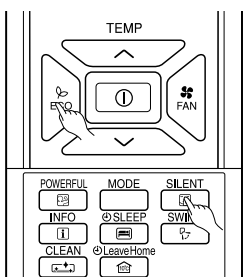

## ■ Method to unlock COOLING and DEHUMIDIFYING modes (including FAN) operations.

Press (ECO) and (SILENT) buttons simultaneously for about 5 seconds when the remote controller is OFF.

All operation mode symbols will appear on the display for about 10 seconds. After that, operation mode symbol before cancellation will be displayed.

This indicates that COOLING and DEHUMIDIFYING modes operation is unlocked.

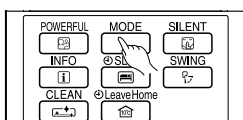

## NOTE

- Operation Mode Lock function will not activate if TIMER reservations activate. TIMER reservations shall be deactivated first. Then, Operation Mode Lock function can be activated.
- HEATING, COOLING and DEHUMIDIFYING mode (including FAN) operations can be unlocked by pressing the (RESET) button. However, by pressing the (RESET) button, all the information stored in the remote controller will disappear. You may need to set the necessary information again.
- For multi connections, unit and mode which is set to lock HEATING and switched on first shall have higher priority. Other units which are chosen to operate at different modes shall be in STANDBY until either the first unit operation is switched off or the mode is selected to be same as the first unit.

# CONSTRUCTION AND DIMENSIONAL DIAGRAM

## MODEL RAK-60PPA

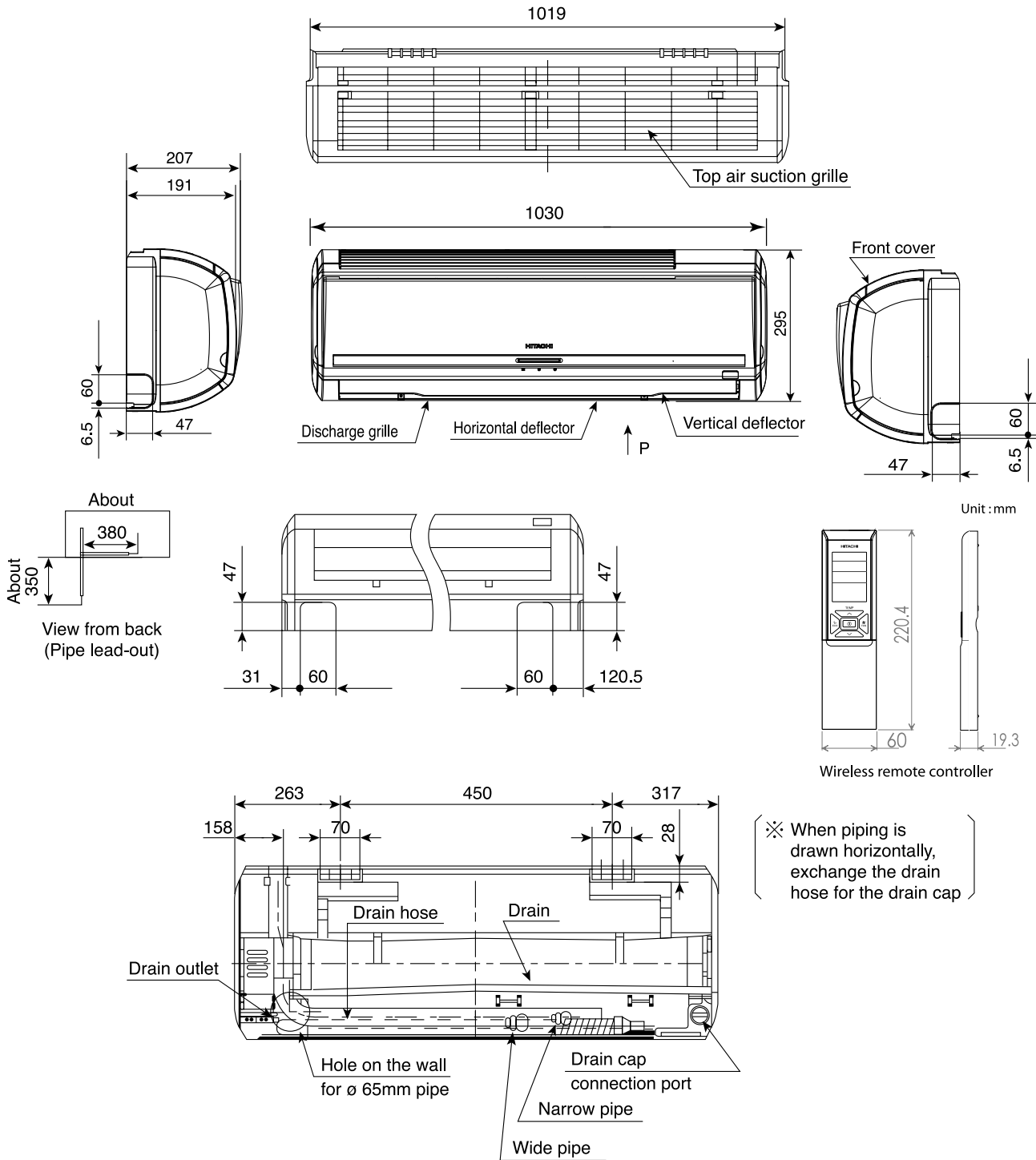

# CONSTRUCTION AND DIMENSIONAL DIAGRAM

## MODEL RAC-60WPA

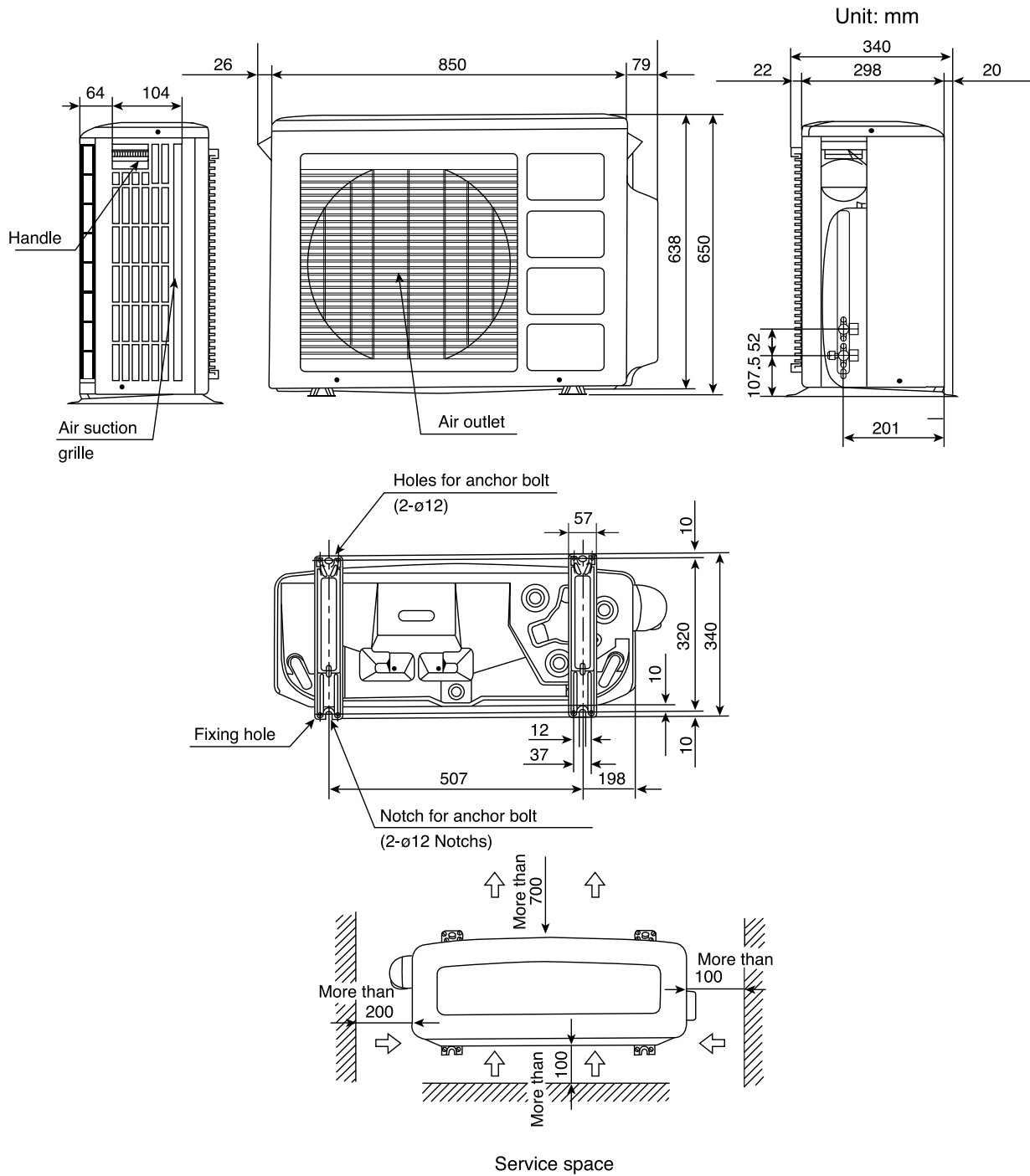

# MAIN PARTS COMPONENT

## THERMOSTAT (Room Temperature Thermistor)

### Thermostat Specifications

MODEL			RAK-60PPA	
THERMOSTAT MODEL			IC	
OPERATION MODE			COOL	HEAT
TEMPERATURE °C (°F)	INDICATION 16	ON	15.6 (60.1)	20.0 (68.0)
		OFF	15.3 (59.5)	20.7 (69.3)
	INDICATION 24	ON	23.6 (74.5)	28.0 (82.4)
		OFF	23.3 (73.9)	28.7 (83.7)
	INDICATION 32	ON	31.6 (88.9)	36.0 (96.8)
		OFF	31.3 (88.3)	36.7 (98.1)

## INDOOR FAN MOTOR

### Fan Motor Specifications

MODEL	RAK-60PPA
POWER SOURCE	DC: 100 ~ 322V
OUTPUT	38W
CONNECTION	<p>(Control circuit built in)</p>

## OUTDOOR FAN MOTOR

### Fan Motor Specifications

ITEM	MODEL	RAC-60WPA			
POWER SOURCE		DC: 120 ~ 380V			
OUTPUT	(W) MAX	47			
COIL					
RESISTANCE VALUE (Ω)	20°C	2M	U-V 35 ± 2.5	V-W 35 ± 2.5	W-U 35 ± 2.5

BLU : BLUE  
GRY : GRAY  
BLK : BLACK

YEL : YELLOW  
ORN : ORANGE  
PNK : PINK

BRN : BROWN  
GRN : GREEN  
VIO : VIOLET

WHT : WHITE  
RED : RED

# COMPRESSOR MOTOR

## Compressor Motor Specifications

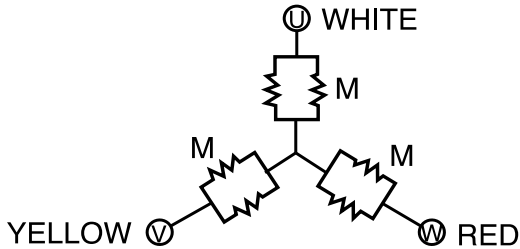
MODEL		RAC-60WPA
COMPRESSOR MODEL		JU1015D9
PHASE		SINGLE
RATED VOLTAGE		AC 220 ~ 240 V
RATED FREQUENCY		50 Hz
POLE NUMBER		4
CONNECTION		
RESISTANCE VALUE ( $\Omega$ )	20°C (68°F)	2M = 1.2984
	75°C (167°F)	2M = 1.7671

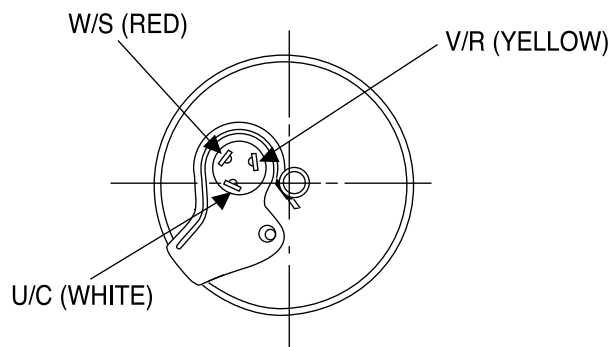

### **CAUTION**

When the Air Conditioner has been operated for a long time with the capillary tubes clogged or crushed or with too little refrigerant, check the color of the refrigerant oil inside the compressor. If the color has been changed conspicuously, replace the compressor.



# WIRING DIAGRAM

MODEL RAK-60PPA / RAC-60WPA

BLU : BLUE  
 GRY : GRAY  
 BLK : BLACK

YEL : YELLOW  
 ORN : ORANGE  
 PNK : PINK

BRN : BROWN  
 GRN : GREEN  
 VIO : VIOLET

WHT : WHITE  
 RED : RED  
 IVO : IVORY

## INDOOR UNIT

## OUTDOOR UNIT

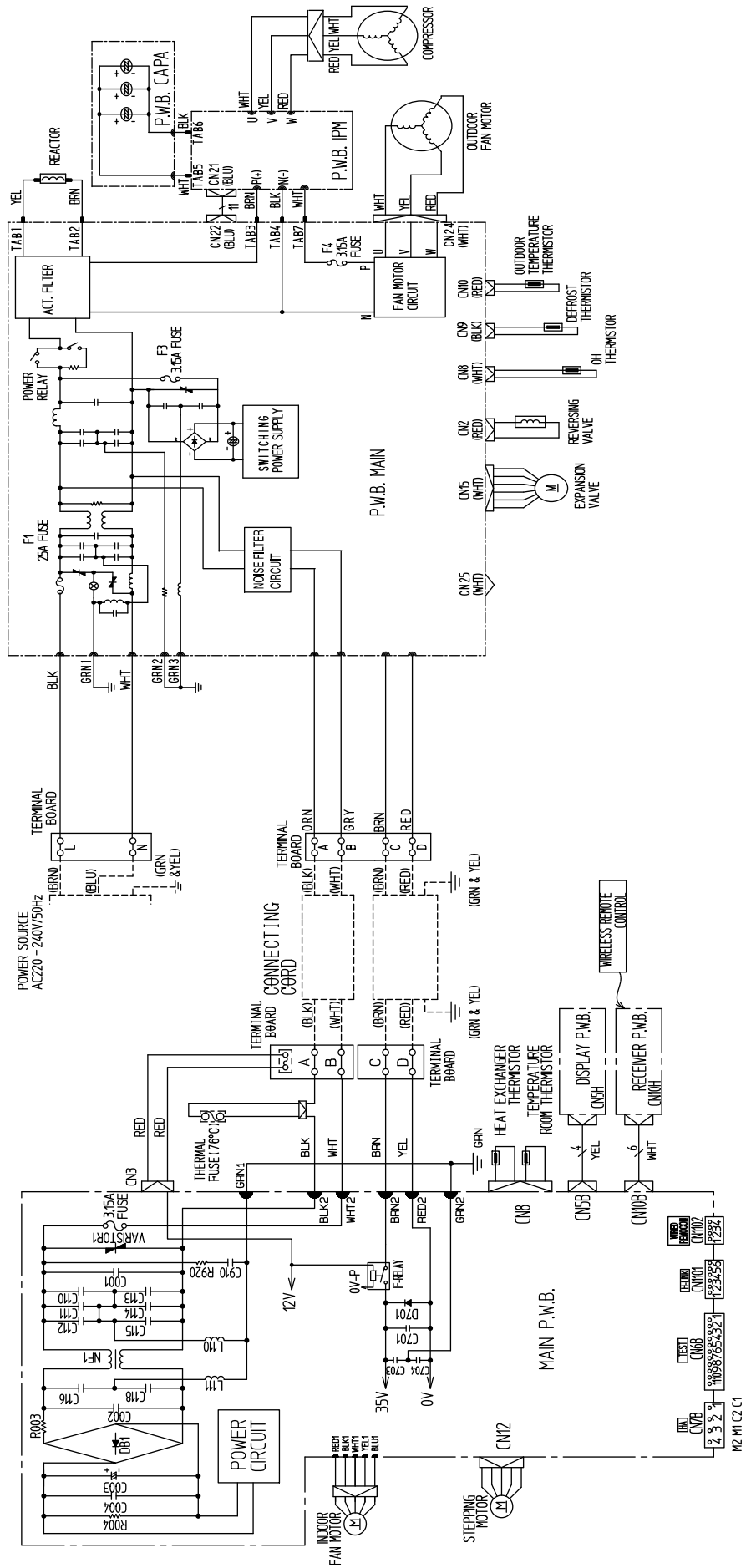

# CIRCUIT DIAGRAM

Remote Control

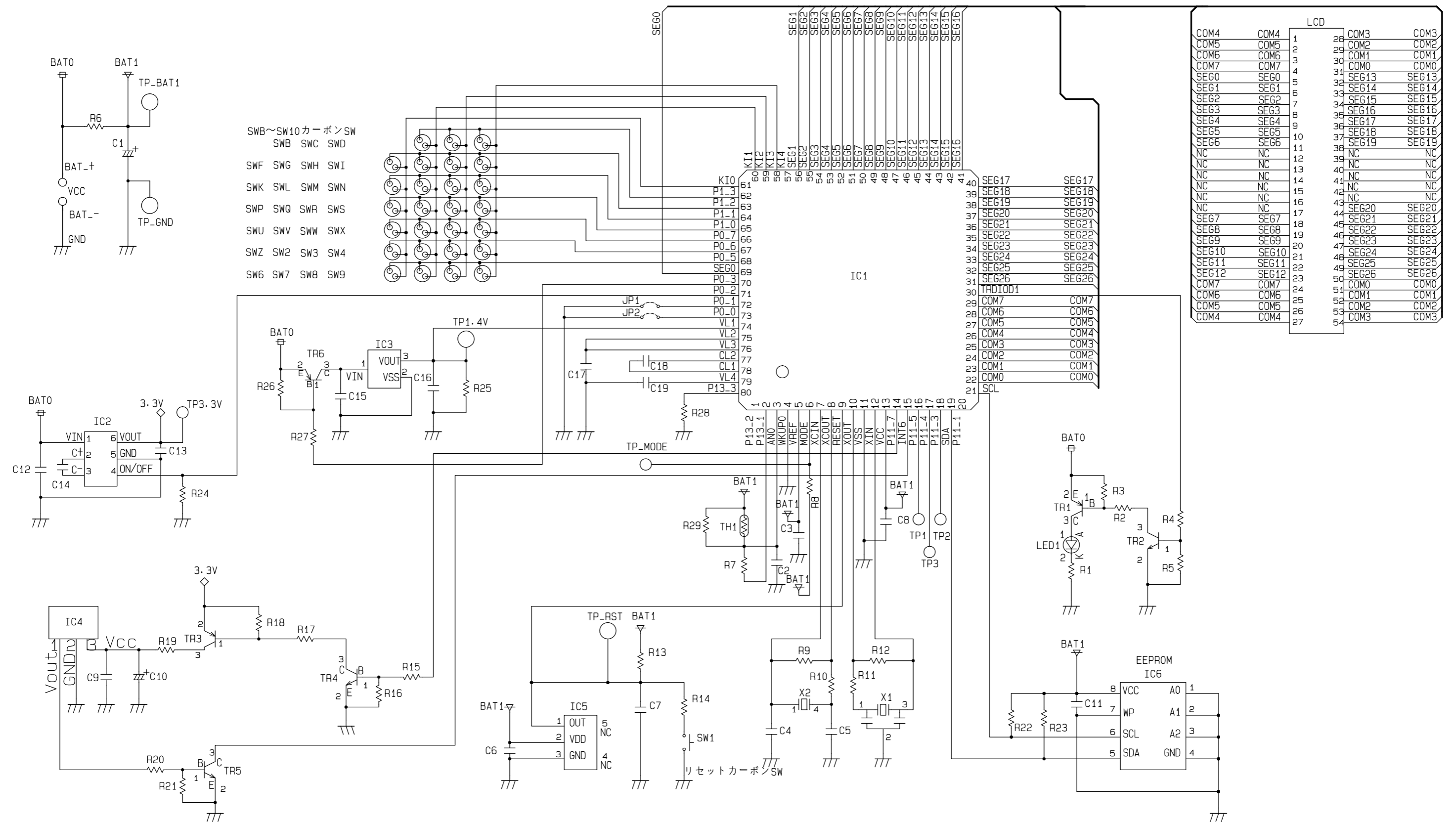





# PRINTED WIRING BOARD LOCATION DIAGRAM

MODEL RAK-60PPA

## MAIN P.W.B.

Marking on P.W.B

COMPONENT SIDE

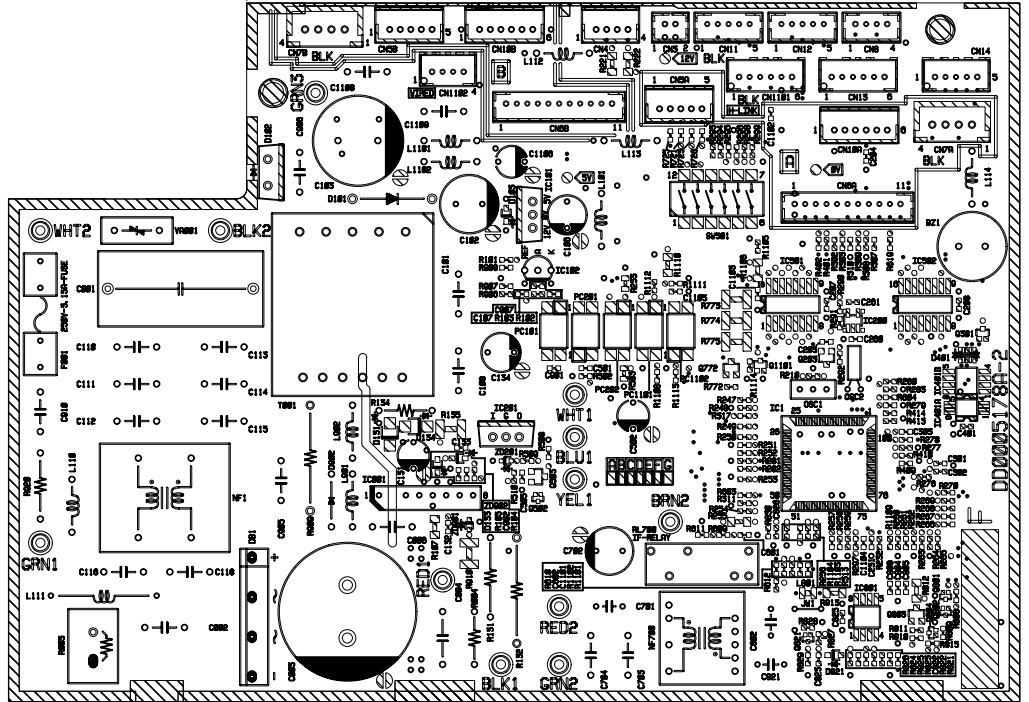

SOLDERING SIDE

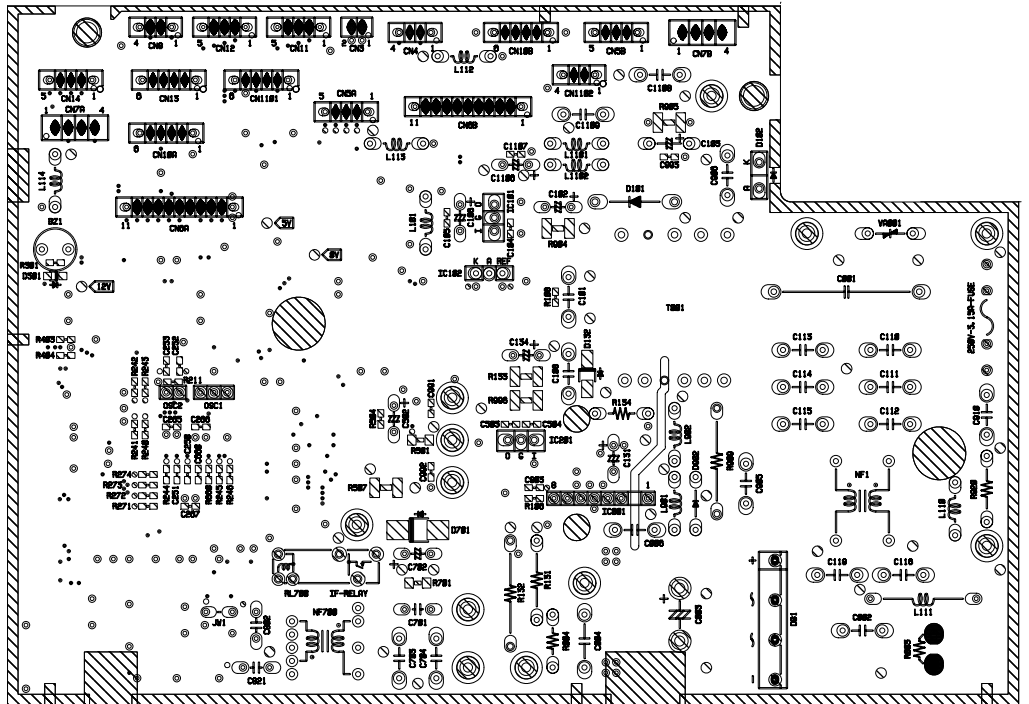

## RECEIVING P.W.B.

Marking on P.W.B

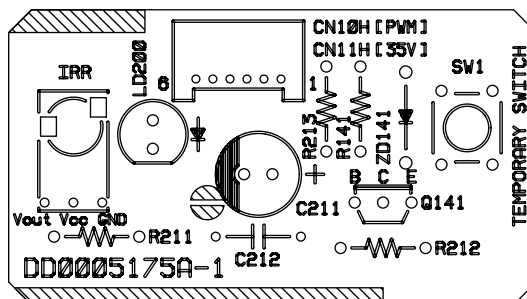

MODEL RAC-60WPA  
P.W.B. MAIN

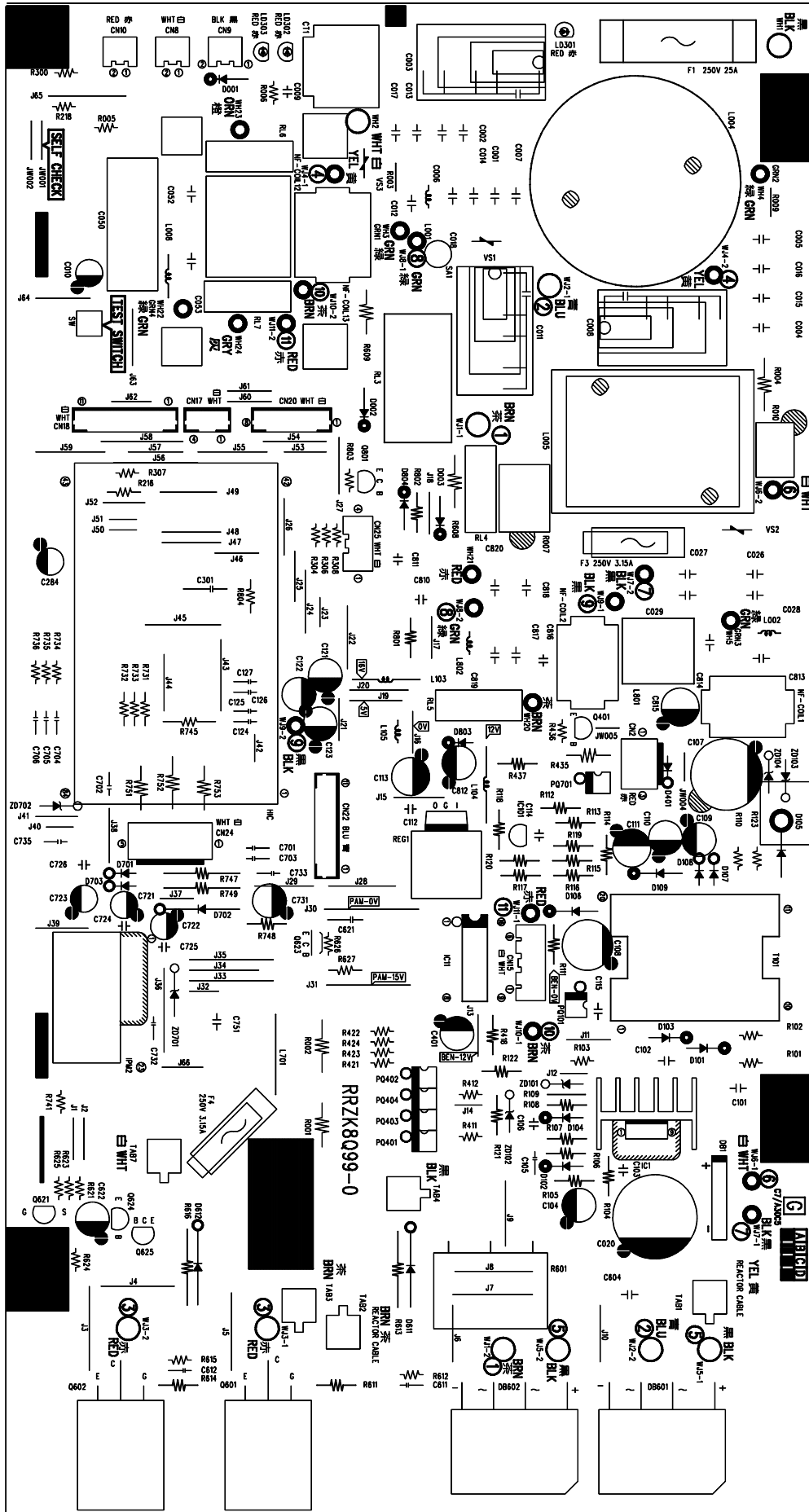

P.W.B. IPM

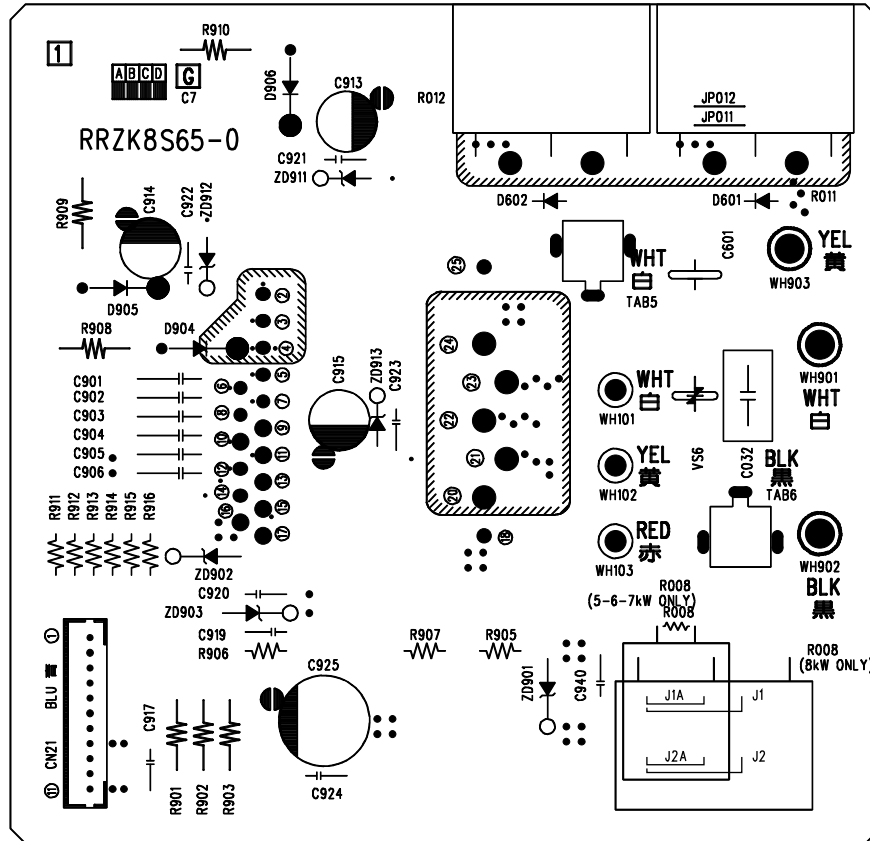

P.W.B. CAPA-BOARD

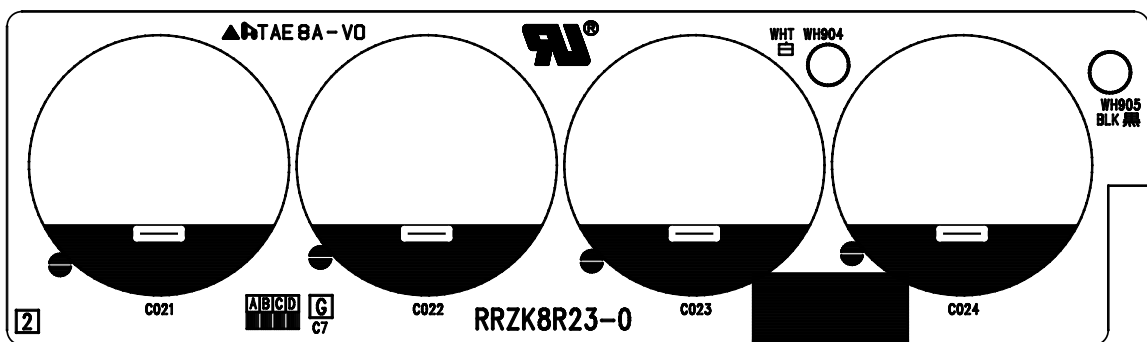

**BLOCK DIAGRAM**  
MODEL RAK-60PPA/RAC-60WPA

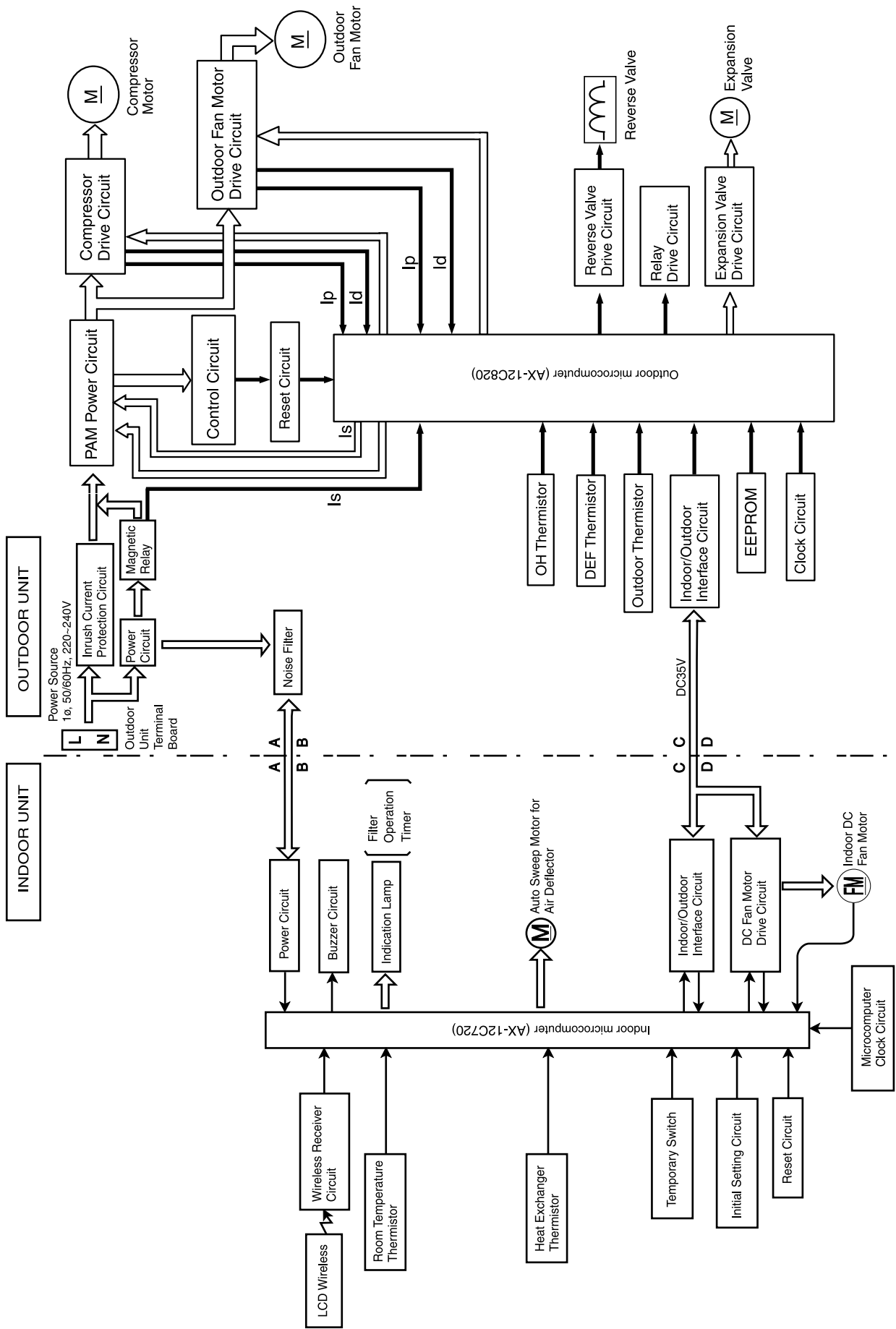



# BASIC MODE

Operation mode	Fan	Cooling	Dehumidifying (dehumidifying operation by the function select button only, not including that engaged by the dehumidify button)	Heating	Auto										
Basic operation of start/stop switch															
Timer functions	Off-timer														
	On-timer														
	Off -> On On -> Off timer														
Fan speed mode (indoor fan)	Auto	<p>Changes from "Hi" to "Med" or "Lo" depending on room temperature.</p> <p>1. Runs at "Hi" until first thermo off after operation is started. 2. Runs at "Lo" when thermo is off.</p>	<p>Changes between "Lo" and "Med" depending on the room temperature.</p> <table border="1"> <thead> <tr> <th>Temperature division</th> <th>Fan speed</th> </tr> </thead> <tbody> <tr> <td>Division 1</td> <td>Lo</td> </tr> <tr> <td>Division 2</td> <td>Lo</td> </tr> <tr> <td>Division 3</td> <td>Med</td> </tr> <tr> <td>Division 4</td> <td>Med</td> </tr> </tbody> </table> <p>1. The indoor fan also stops when the compressor is in stop status.</p>	Temperature division	Fan speed	Division 1	Lo	Division 2	Lo	Division 3	Med	Division 4	Med	<p>Set to "ultra-Lo", "Lo", "Med", "Hi", "ultra-Hi" or "stop" depending on the room temperature, time and heat exchange temperature. Set to "stop" if the room temperature is 25°C in the "ultra-Lo" mode other than during preheating (cooling is recovered at 18.33°C).</p> <p>When the compressor is running at maximum speed during hot dash or when recovered from defrosting.</p> <p>In modes other than left</p>	<p>Operating mode is judged by room temperature and outdoor temperature.</p> <p>(1) Judging by outdoor temperature</p> <ul style="list-style-type: none"> <li>Operating mode is judged by outdoor temperature. Only when the mode is not restricted by this judgment, the judgment by room temperature in the next paragraph will be performed.</li> <li>(a) Outdoor temperature <math>\geq 30^{\circ}\text{C}</math> : Restricted to cooling</li> <li>(b) Outdoor temperature <math>\leq 9^{\circ}\text{C}</math> : Restricted to heating</li> </ul> <p>(2) Judging by room temperature</p> <p>Operating mode at start up is judged (initial judgment)</p> <p>(a) Conditions for judgment (any of the followings)</p> <ul style="list-style-type: none"> <li>When auto operation is started after 1 hour has elapsed since the operation was stopped.</li> <li>When auto operation is started after the previous manual mode operation.</li> <li>When the operating mode is switched to auto while operating at manual mode.</li> </ul> <p>(b) Judging method</p> <ul style="list-style-type: none"> <li>Room temperature <math>\geq 23^{\circ}\text{C} \pm 3^{\circ}\text{C}</math> : Cooling</li> <li>Room temperature <math>&lt; 23^{\circ}\text{C} \pm 3^{\circ}\text{C}</math> : Heating</li> <li>* <math>\pm 3^{\circ}\text{C}</math> is the fine adjustment value from the remote controller.</li> </ul>
	Temperature division	Fan speed													
	Division 1	Lo													
	Division 2	Lo													
Division 3	Med														
Division 4	Med														
Hi	Operates at "Hi" regardless of the room temperature.	Set to "ultra-Hi" when the compressor runs at maximum speed, and to "Hi" in other modes.	Set to "Hi" in modes other than when the compressor stops.	Set to "ultra-Lo", "Lo", "Med", "Hi", "ultra-Hi" or "stop" depending on the room temperature, and time. Set to "stop" if the room temperature is 25°C in the "ultra-Lo" mode other than during preheating (cooling is recovered at 18.33°C). Set to "ultra-Hi" when the compressor is running at maximum speed during hot dash or when recovered from defrosting.	<p>Judging operating mode change during operation (Continuous judgment)</p> <p>(a) Conditions for judgment (any of the followings)</p> <ul style="list-style-type: none"> <li>The mode is reviewed at every interval time.</li> <li>When auto operation is started again before 1 hour has elapsed since the operation was stopped.</li> </ul> <p>(b) Judging method</p> <ul style="list-style-type: none"> <li>Judge by setting the hysteresis on the final preset temperature. The final preset temperature is the actually targeted preset temperature which is the sum of the basic preset temperature and each type of shift value (e.g. <math>\pm 3^{\circ}\text{C}</math> by remote controller, preset temperature correction value, powerful shift value, etc.).</li> </ul> <p>[Currently cooling]</p> <ul style="list-style-type: none"> <li>Room temperature <math>\leq</math> Final preset temperature <math>-3^{\circ}\text{C}</math> Change to heating</li> <li>Room temperature <math>&lt;</math> Final preset temperature <math>-3^{\circ}\text{C}</math> Continue cooling</li> </ul> <p>[Currently heating]</p> <ul style="list-style-type: none"> <li>Room temperature <math>\geq</math> Final preset temperature <math>+2^{\circ}\text{C}</math> Change to cooling</li> <li>Room temperature <math>&lt;</math> Final preset temperature <math>+2^{\circ}\text{C}</math> Continue heating</li> </ul>										
Med	Operates at "Med" regardless of the room temperature.	Same as at left.	Set to "Med" in modes other than when the compressor stops.	Set to "ultra-Lo", "Lo", "Med" or "stop" depending on the room temperature and time. Set to "stop" if the room temperature is 25°C in the "ultra-Lo" mode other than during preheating (cooling is recovered at 18.33°C).											
Lo	Operates at "Lo" regardless of the room temperature.	Same as at left.	Set to "Lo" in modes other than when the compressor stops.	Set to "ultra-Lo", "Lo", or "stop" depending on the room temperature and time. Set to "stop" if the room temperature is 25°C in the "ultra-Lo" mode other than during preheating (cooling is recovered at 18.33°C). The fan speed is controlled by the heat exchanger temperature; the overload control is executed as in the following diagram:											
Basic operation of temperature controller	Performs only fan operation at the set speed regardless of the room temperature.	See page 63.	See page 67.	See page 71.											
Sleep operation (with sleep button ON)	<ul style="list-style-type: none"> <li>Enters sleep operation after set as on the left.</li> <li>Action during sleep operation Lo (sleep) operation</li> </ul>	<ul style="list-style-type: none"> <li>Same as at left</li> <li>See page 65.</li> </ul>	<ul style="list-style-type: none"> <li>Same as at left</li> <li>See page 69.</li> </ul>	<ul style="list-style-type: none"> <li>Same as at left</li> <li>See page 73.</li> </ul>	<ul style="list-style-type: none"> <li>Same as at left.</li> <li>Performs the sleep operation of each operation mode.</li> </ul>										

**Table 1 Mode data file**

	<b>RAK-60PPA</b>
<b>LABEL NAME</b>	<b>VALUE</b>
WMAX	5200 min <sup>-1</sup>
WMAX2	5200 min <sup>-1</sup>
WSTD	4750 min <sup>-1</sup>
WBEMAX	3600 min <sup>-1</sup>
CMAX	5000 min <sup>-1</sup>
CSTD	4600 min <sup>-1</sup>
CKYMAX	3900 min <sup>-1</sup>
CJKMAX	3900 min <sup>-1</sup>
CBEMAX	2300 min <sup>-1</sup>
WMIN	1200 min <sup>-1</sup>
CMIN	1600 min <sup>-1</sup>
STARTMC	60 Seconds
DWNRATEW	100%
DWNRATEC	100%
SHIFTW	0°C
SHIFTC	1°C
CLMXTP	30.00°C
YNEOF	25.00°C
TEION	2.00°C
TEIOF	9.00°C
SFTDSW	0.66°C
DFTIM1	50 Minutes
DFTIM2	60 Minutes

## Basic Cooling Operation

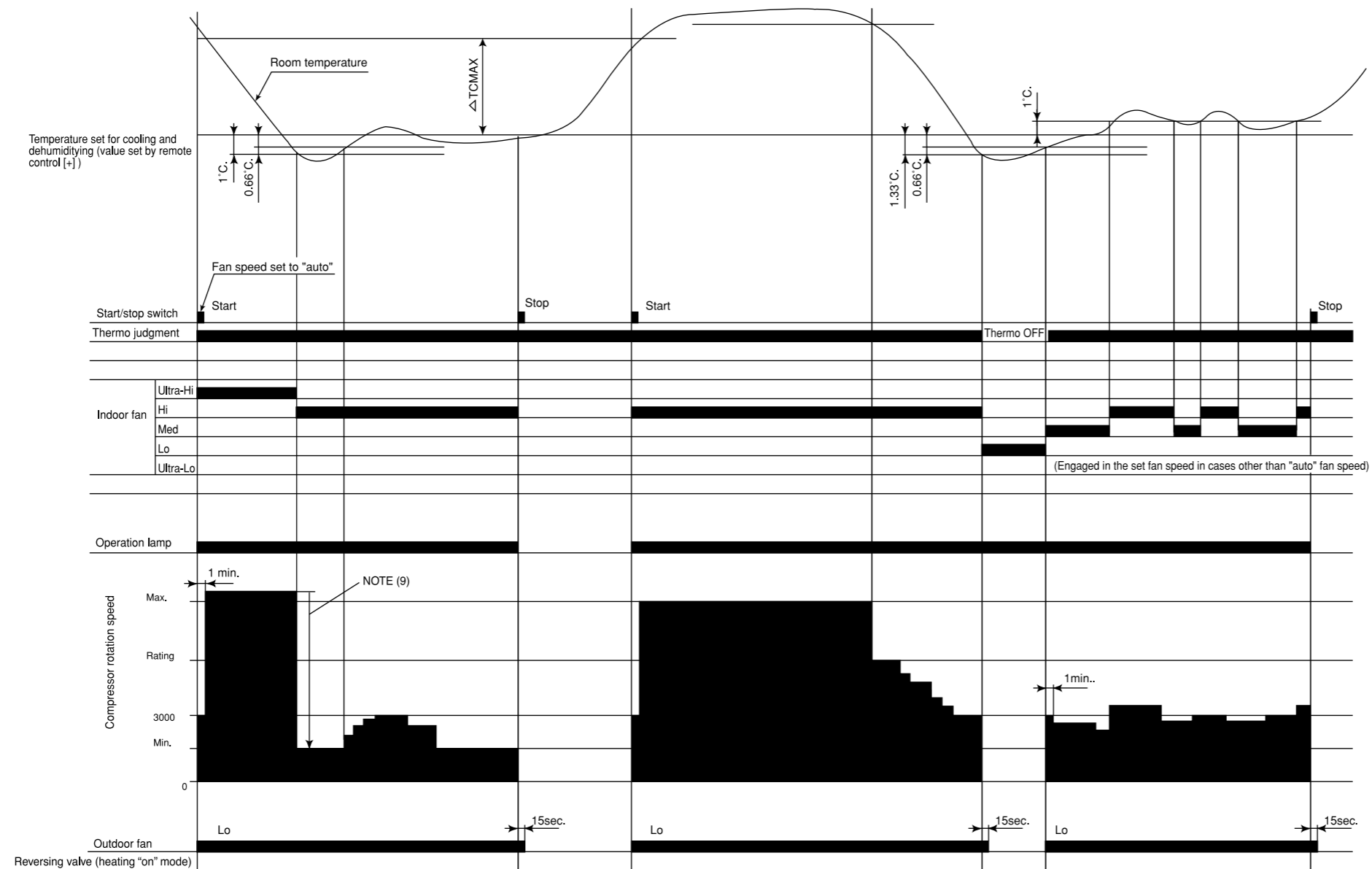
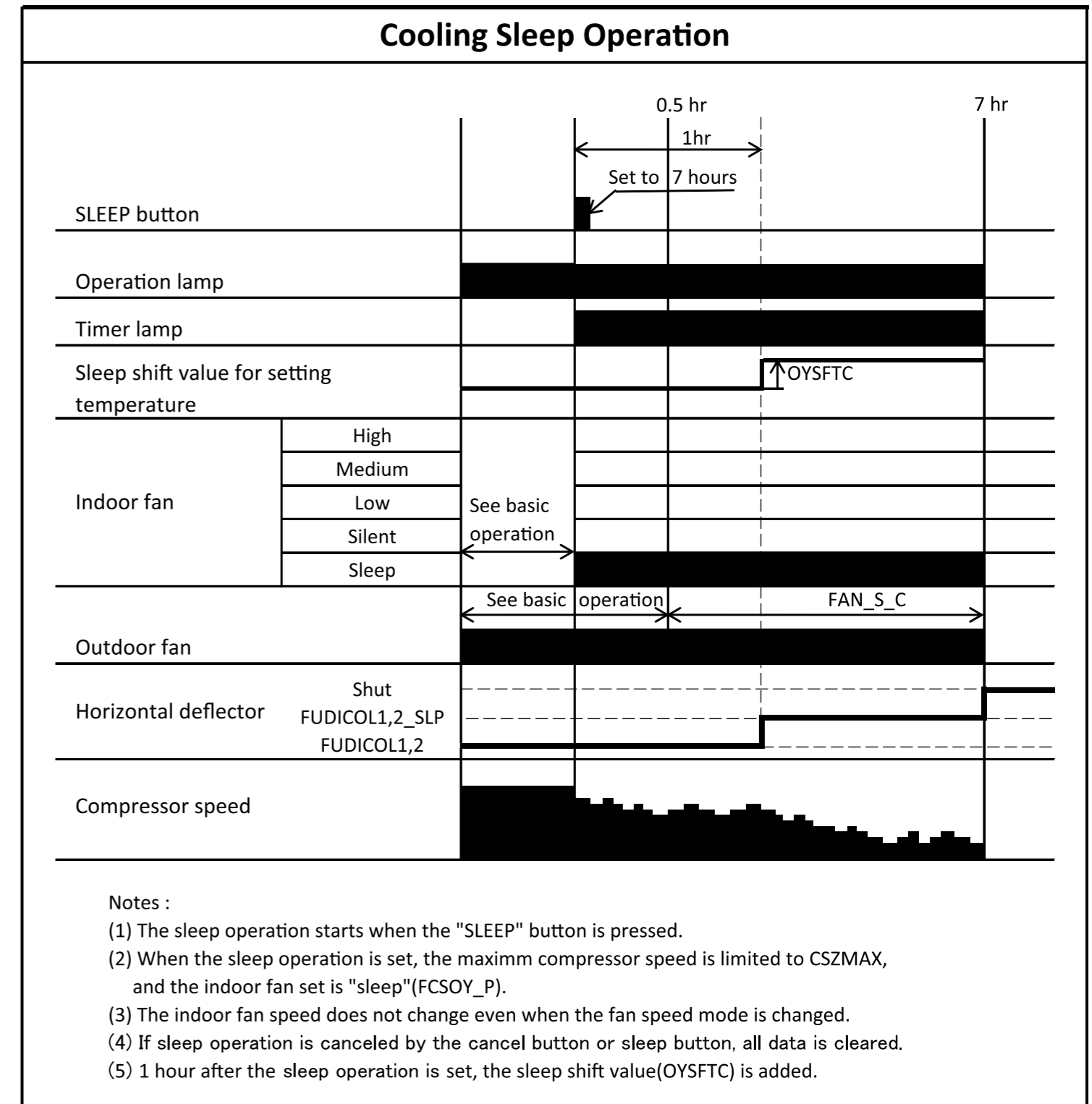
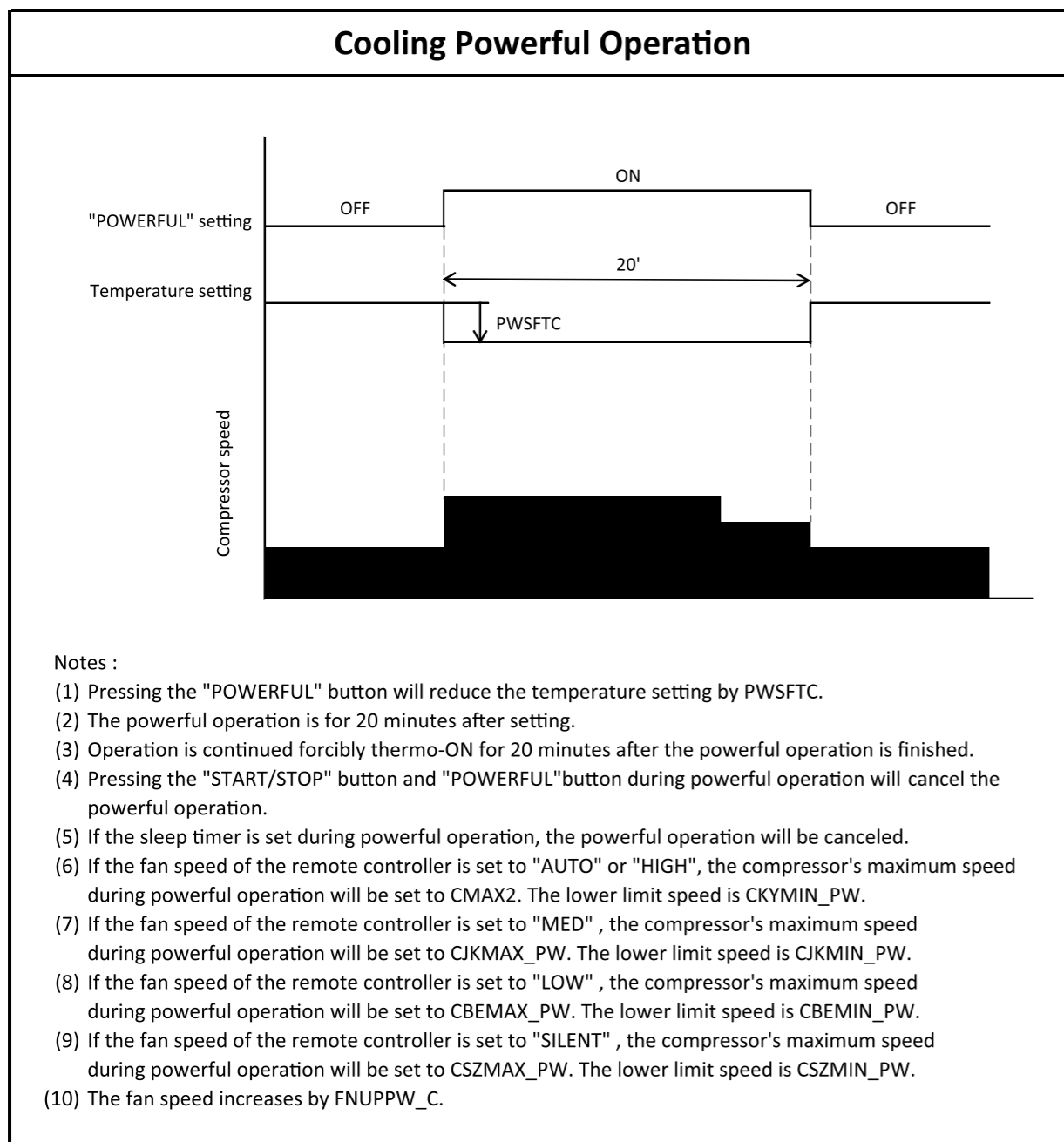
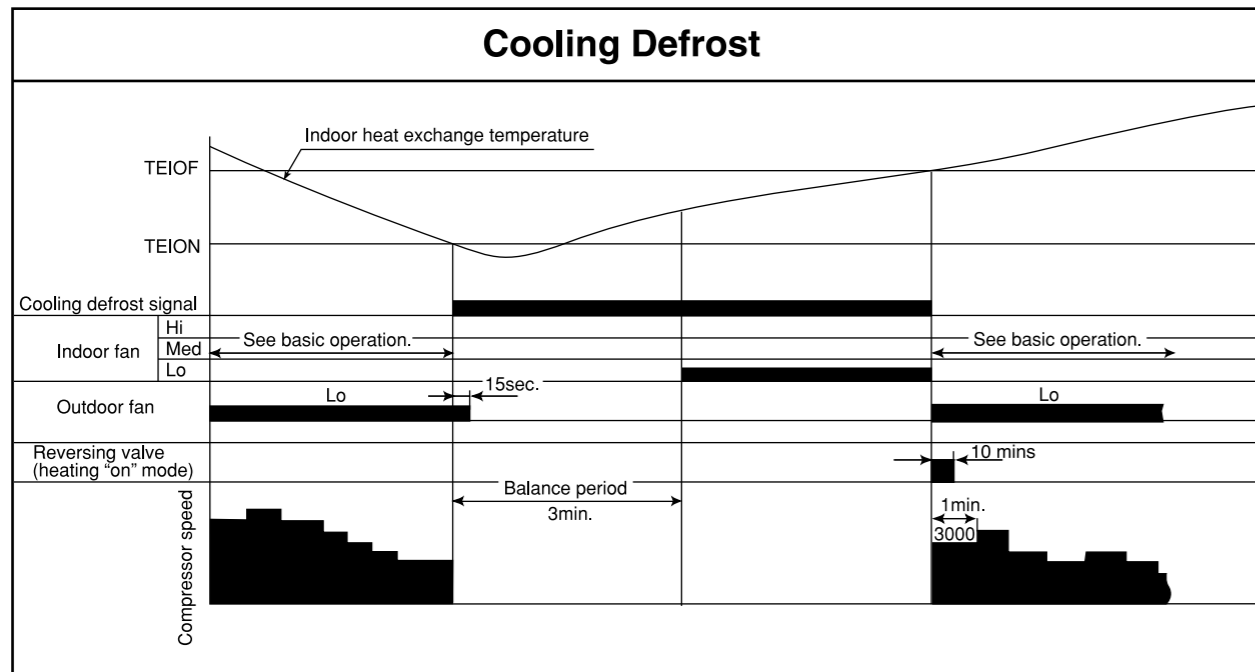

Table 2 ΔTCMAX

Temperature difference	Calculated compressor rpm
1.66	2265 min <sup>-1</sup>
2	2435 min <sup>-1</sup>
2.33	2600 min <sup>-1</sup>
2.66	2765 min <sup>-1</sup>
3	2935 min <sup>-1</sup>
3.33	3100 min <sup>-1</sup>
3.66	3265 min <sup>-1</sup>
4	3435 min <sup>-1</sup>
4.33	3600 min <sup>-1</sup>
4.66	3765 min <sup>-1</sup>
5	3935 min <sup>-1</sup>
5.33	4100 min <sup>-1</sup>
5.66	4265 min <sup>-1</sup>
6	4435 min <sup>-1</sup>
6.33	4600 min <sup>-1</sup>
6.66	4765 min <sup>-1</sup>
7	4935 min <sup>-1</sup>
7.33	5100 min <sup>-1</sup>
7.66	5265 min <sup>-1</sup>
8	5435 min <sup>-1</sup>
8.33	5600 min <sup>-1</sup>
8.66	5765 min <sup>-1</sup>
9	5935 min <sup>-1</sup>
9.33	6100 min <sup>-1</sup>
9.66	6265 min <sup>-1</sup>
10	6435 min <sup>-1</sup>
10.33	6600 min <sup>-1</sup>
10.66	6765 min <sup>-1</sup>
11	6935 min <sup>-1</sup>

**Notes:**

- (1) Condition for entering into Cool Dashed mode. When fan set to “Hi” or “Auto mode” and temperature difference between indoor temperature and set temperature has a corresponding compressor rpm (calculated value in Table 2) larger than CMAX.
- (2) Cool Dashed will release when i) a maximum 25 minutes is lapsed and ii) room temperature is lower than set temperature -3°C (thermo off) and iii) when room temperature has achieved setting temperature -1°C then maximum Cool Dashed time will be revised to 20 minutes. And iv) indoor fan is set to Lo and Med fan mode and v) change operation mode.
- (3) During Cool Dashed operation, thermo off temperature is set temperature (with shift value) -3°C. After thermo off, operation continue in Fuzzy control mode.
- (4) Compressor minimum “ON” time and “OFF” time is 3 minutes.
- (5) During normal cooling mode, compressor maximum rpm CMAX will maintain for 60 minutes if indoor temperature is lower than CLMXTP. No time constrain if indoor temperature is higher than CLMXTP.
- (6) When fan is set to “Hi”, compressor rpm will be limited to CKYMAX.
- (7) When fan is set to “Med”, compressor rpm will be limited to CJKMAX.
- (8) When fan is set to “Lo”, compressor rpm will be limited to CBEMAX.
- (9) During Cool Dashed, when room temperature reaches set temperature -1°C compressor rpm is actual rpm x DWNRATEC.



# Dehumidifying

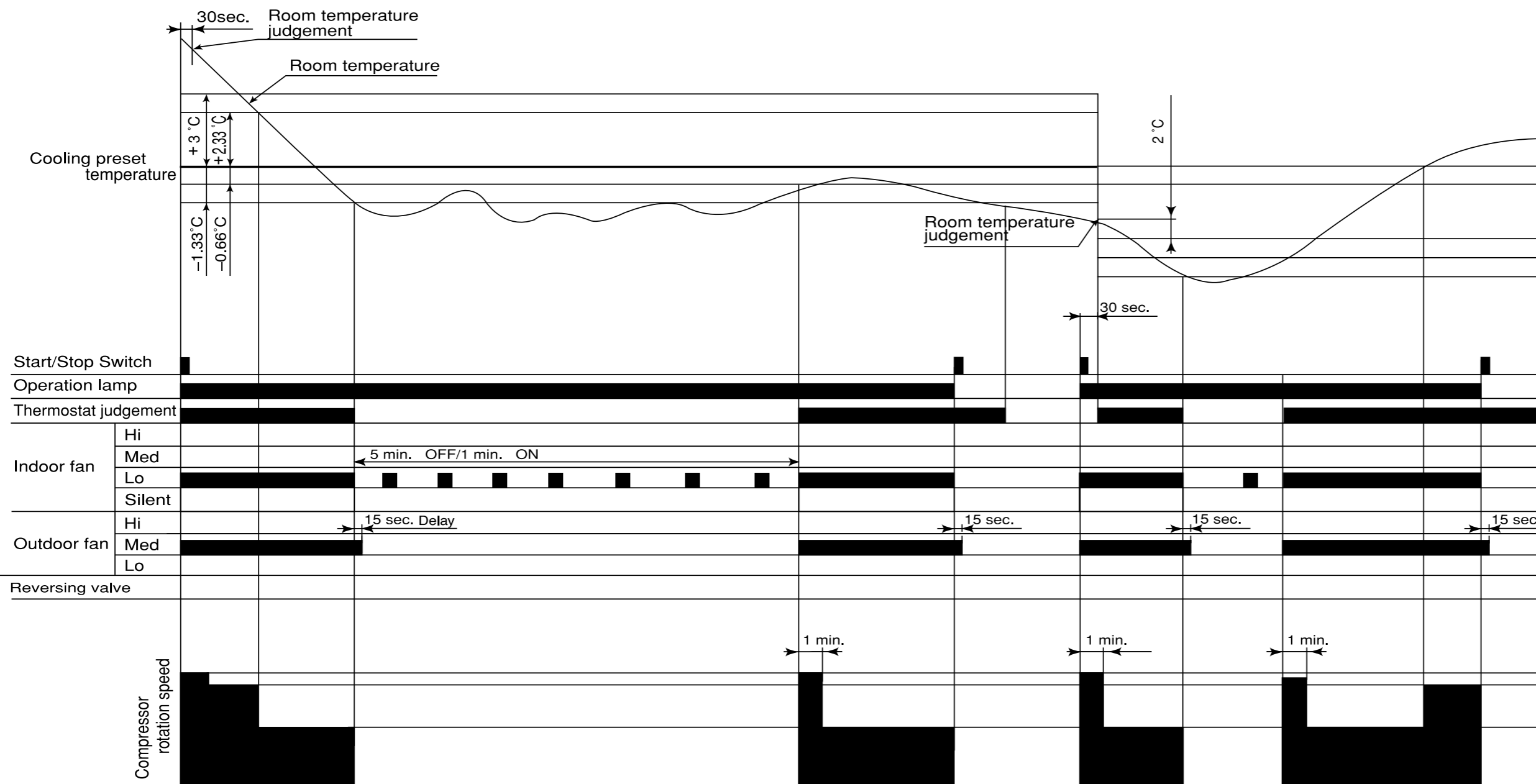

**Notes:**

- (1) If the room temperature is (cooling preset temperature) - (1.33°C) or less after 30 seconds from starting the operation, the operation is done assuming as the preset temperature = (room temperature at the time) - (2°C).
- (2) The indoor fan is operated in the "Lo" mode. During thermo OFF indoor fan will be OFF for 5 minutes and ON for 1 minute.
- (3) When the operation is started by the thermostat turning ON, the start of the indoor fan is delayed 32 seconds after the start of compressor operation.
- (4) The compressor is operated forcedly for 3 minutes after operation is started.
- (5) The minimum ON time and OFF time of the compressor are 3 minutes.

## Dehumidifying Sleep Operation

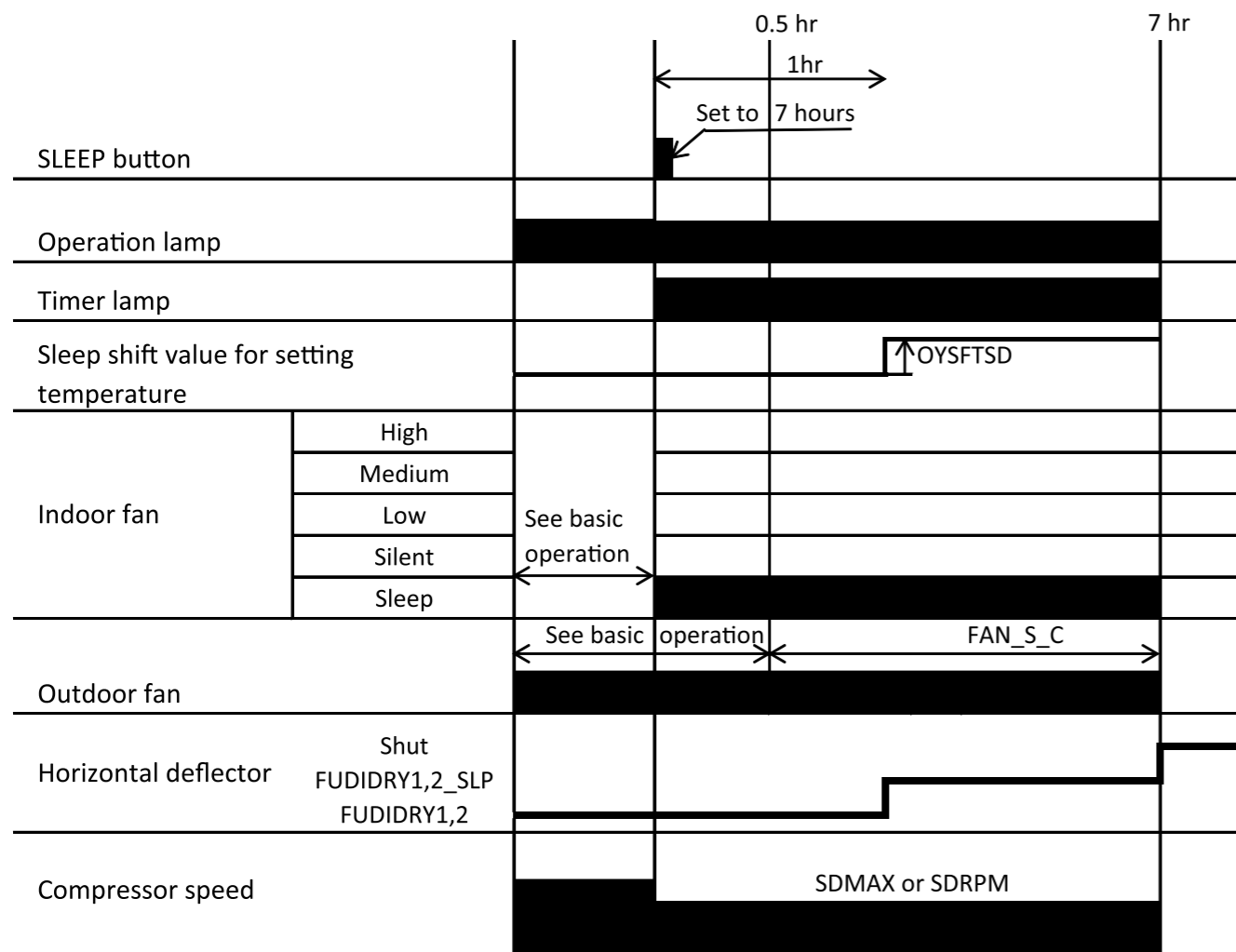

### Notes :

- (1) The sleep operation starts when the "SLEEP" button is pressed.
- (2) When the sleep operation is set, the indoor fan set is "sleep"(FDOY\_P).
- (3) The indoor fan speed does not change even when the fan speed mode is changed.
- (4) If sleep operation is canceled by the cancel button or sleep button, all data is cleared.
- (5) 1 hour after the sleep operation is set, the sleep shift value(OYSFTSD) is added.

## Dehumidifying Powerful Operation

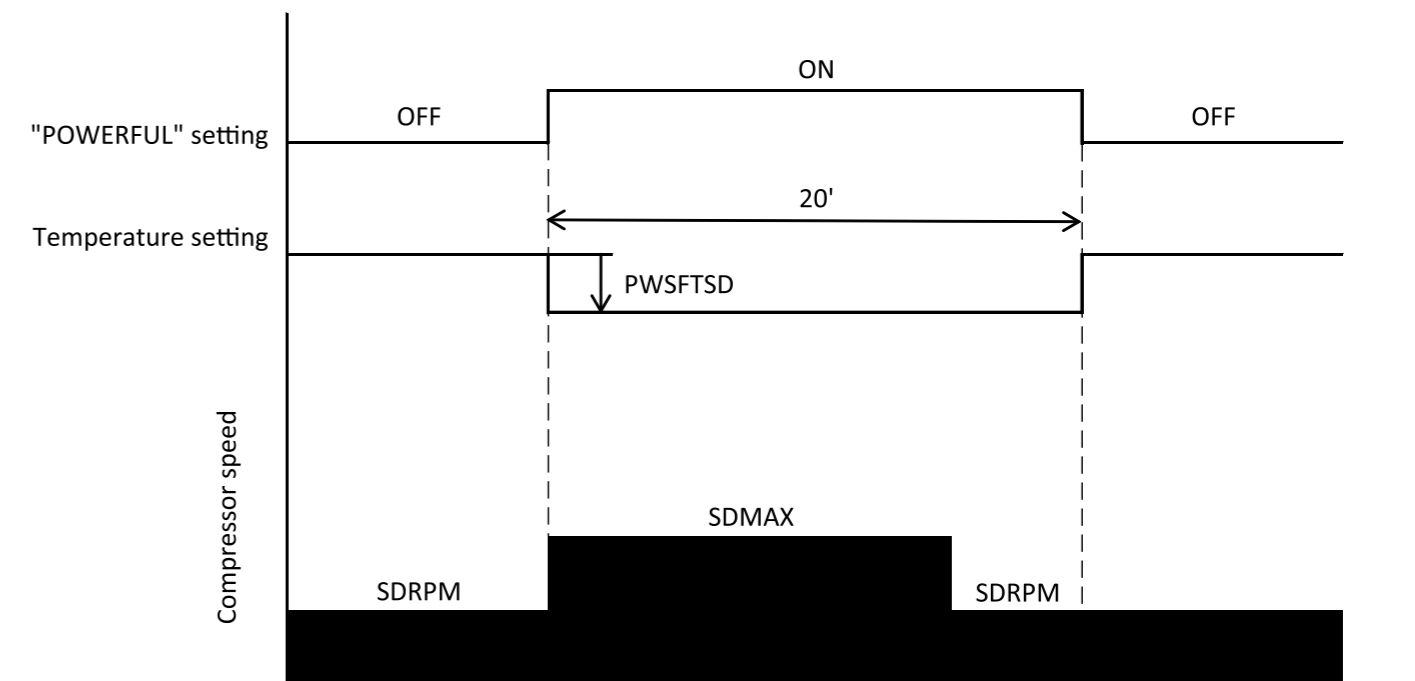

### Notes :

- (1) Pressing the "POWERFUL" button will reduce the temperature setting by PWSFTSD.
- (2) The powerful operation is for 20 minutes after setting.
- (3) Operation is continued forcibly thermo-ON for 20 minutes after the powerful operation is finished.
- (4) Pressing the "START/STOP" button and "POWERFUL" button during powerful operation will cancel the powerful operation.
- (5) If the sleep timer is set during powerful operation, the powerful operation will be canceled.
- (6) If the differential (the room temperature - the temperature setting) is "the differential  $\geq 3^{\circ}\text{C}$ " after powerful setting, the compressor's maximum speed during powerful operation will be set to SDMAX. Then the differential reduce "the differential  $\leq 2.33^{\circ}\text{C}$ " during powerful operation, the compressor's speed will be set to SDRPM. If the differential (the room temperature - the temperature setting) is "the differential  $< 3^{\circ}\text{C}$ " after powerful setting, the compressor's minimum speed during powerful operation will be set to SDRPM.
- (7) The fan speed increases by FNUPPW\_D.

## Basic Heating Operation

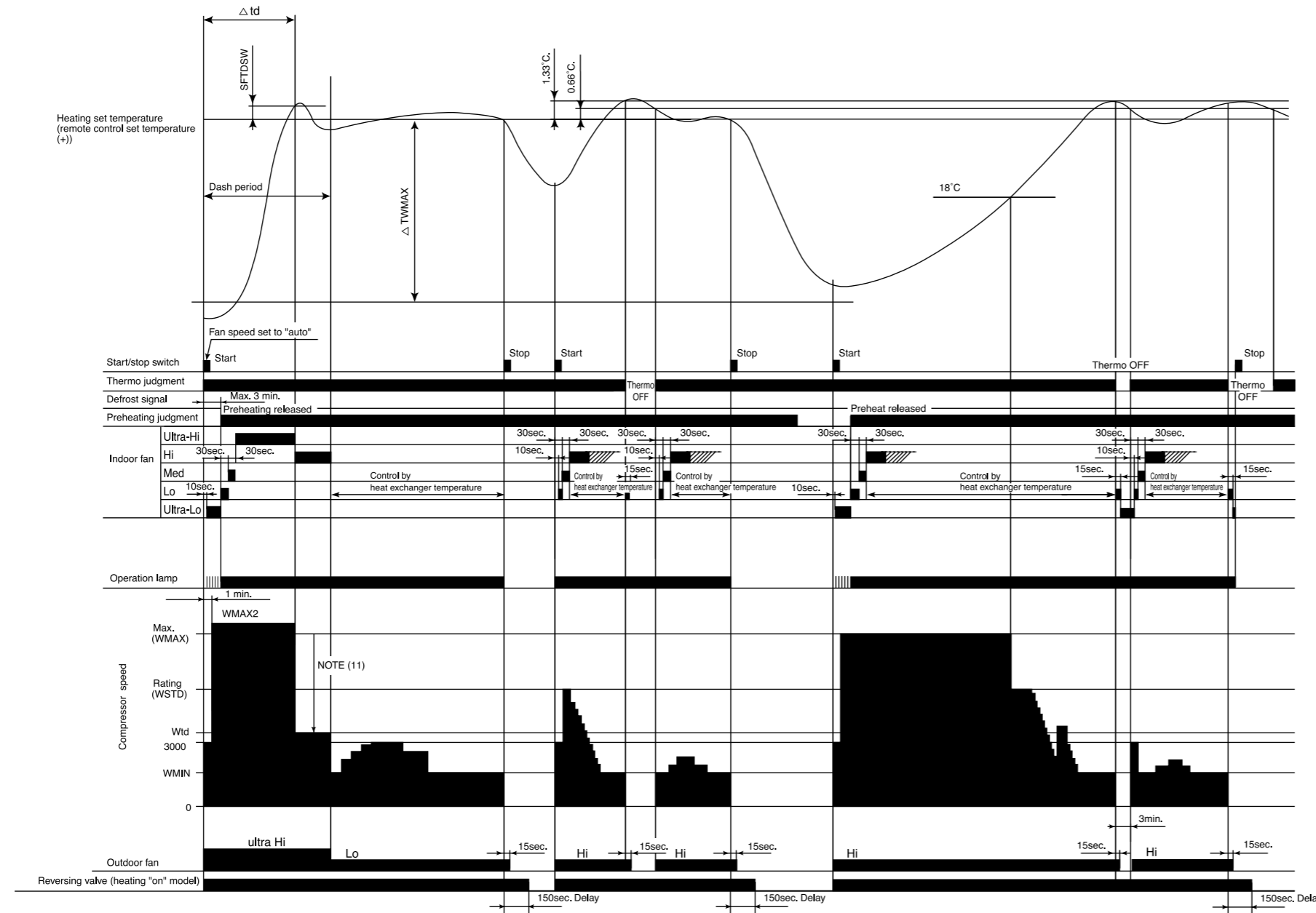

**Notes:**

- (1) Condition for entering into Hot Dashed mode. When fan set to “Hi” or “Auto mode” and i) Indoor temperature is lower than 18°C, and ii) outdoor temperature is lower than 10°C, and iii) Temperature difference between indoor temperature and set temperature has a corresponding compressor rpm (calculated value in Table 3) larger than WMAX.
- (2) Hot Dashed will release when i) Room temperature has achieved the set temperature + SFTDSW. ii) Thermo off.
- (3) During Hot Dashed operation, thermo off temperature is set temperature (with shift value) +3°C. After thermo off, operation continue in Fuzzy control mode.
- (4) Compressor minimum “ON” time and “OFF” time is 3 minutes.
- (5) During normal heating mode, compressor maximum rpm WMAX will maintain for 120 minutes if indoor temperature is higher than 18°C. No time limit constrain if indoor temperature is lower than 18°C and outdoor temperature is lower than 2°C.
- (6) During Hotkeep or Defrost mode, indoor operation lamp will blink at interval of 3 seconds “ON” and 0.5 second “OFF”.
- (7) When heating mode starts, it will enter into Hotkeep mode if indoor heat exchanger temperature is lower than YNEOF + 0.33°C.
- (8) When fan is set to “Med” or “Lo”, compressor rpm will be limited to WBEMAX.
- (9) In “Ultra-Lo” fan mode, if indoor temperature is lower than 18°C, indoor fan will stop. If indoor temperature is higher than 18°C + 0.33°C, fan will continue in “Ultra-Lo” mode. During Hotkeep or Defrost mode, fan will continue in “Ultra-Lo” mode.
- (10) During Hot Dashed or outdoor temperature is lower than -5°C, compressor rpm is WMAX2.
- (11) During Hot Dashed, when room temperature reaches set temperature + SFTDSW compressor rpm is actual rpm x DWNRATEW.

Table 3 ΔTWMAX

Temperature difference	Calculated compressor rpm
1.66	1965 min <sup>-1</sup>
2	2135 min <sup>-1</sup>
2.33	2300 min <sup>-1</sup>
2.66	2465 min <sup>-1</sup>
3	2635 min <sup>-1</sup>
3.33	2800 min <sup>-1</sup>
3.66	2965 min <sup>-1</sup>
4	3135 min <sup>-1</sup>
4.33	3300 min <sup>-1</sup>
4.66	3465 min <sup>-1</sup>
5	3635 min <sup>-1</sup>
5.33	3800 min <sup>-1</sup>
5.66	3965 min <sup>-1</sup>
6	4135 min <sup>-1</sup>
6.33	4300 min <sup>-1</sup>
6.66	4465 min <sup>-1</sup>
7	4635 min <sup>-1</sup>
7.33	4800 min <sup>-1</sup>
7.66	4965 min <sup>-1</sup>
8	5135 min <sup>-1</sup>
8.33	5300 min <sup>-1</sup>
8.66	5465 min <sup>-1</sup>
9	5635 min <sup>-1</sup>
9.33	5800 min <sup>-1</sup>
9.66	5965 min <sup>-1</sup>
10	6135 min <sup>-1</sup>
10.33	6300 min <sup>-1</sup>
10.66	6465 min <sup>-1</sup>
11	6635 min <sup>-1</sup>

**Notes:**

1. See the data in Table 1 on page 47 for each constant in capital letters in the diagrams.

## Reversing Valve Defrosting

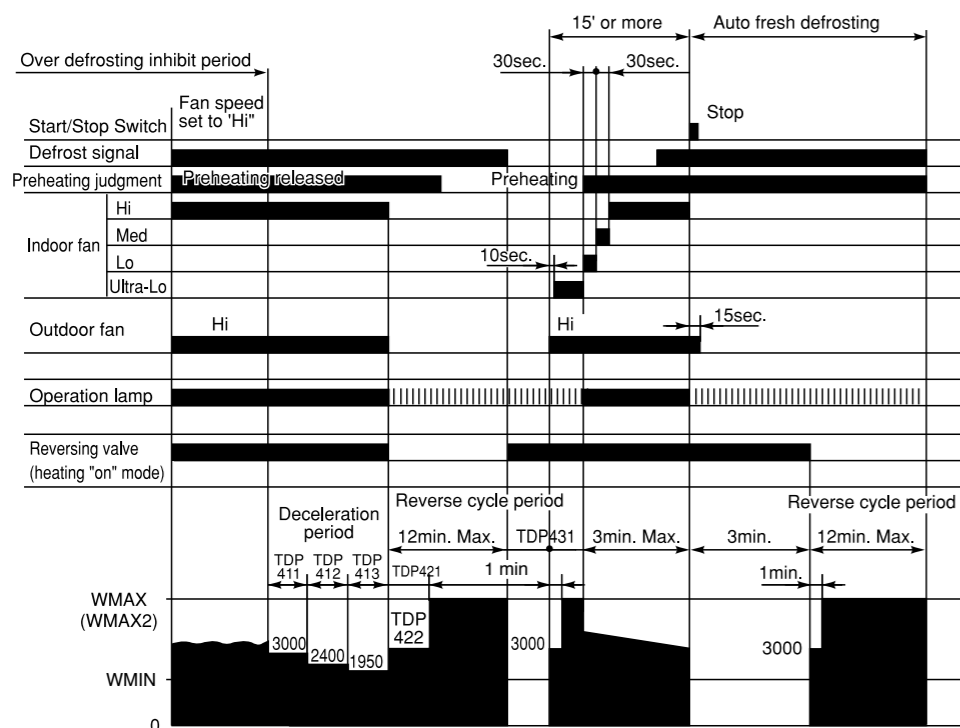

### Notes:

- (1) The defrosting inhibit period is set as shown in the diagram below. When defrosting has finished once, the inhibit period is newly set, based on the outdoor temperature when the compressor was started. During this period, the defrost signal is not accepted.
- (2) If the difference between the room and outdoor temperature is large when defrosting is finished, the maximum compressor speed (WMAX) or (WMAX2) can be continued for 120 minutes maximum.
- (3) The defrosting period is 12 minutes maximum.
- (4) When operation is stopped during defrosting, it is switched to auto refresh defrosting.
- (5) Auto refresh defrosting cannot be engaged within 15 minutes after operation is started or defrosting is finished.

## Setting Defrosting Inhibit Period

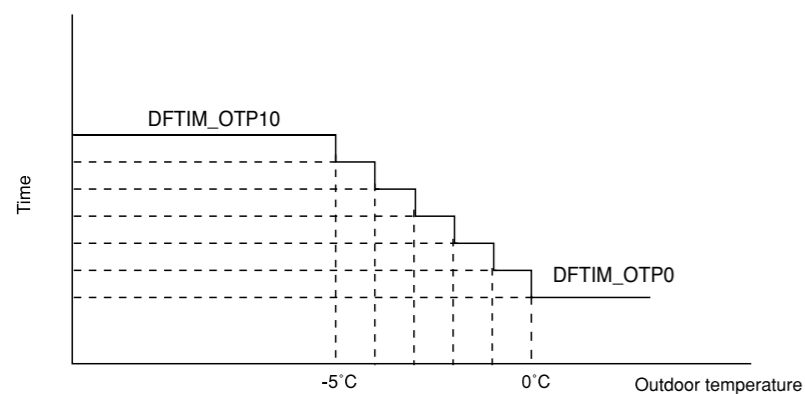

### Notes:

- (1) The time is set according to the outdoor temperature when it is between 0°C and -5°C.
- (2) DFTIM\_OTP0 is used when the outdoor temperature  $\geq 0^\circ\text{C}$ .
- (3) DFTIM\_OTP10 is used when the outdoor temperature  $\leq -5^\circ\text{C}$ .

## Heating Sleep Operation

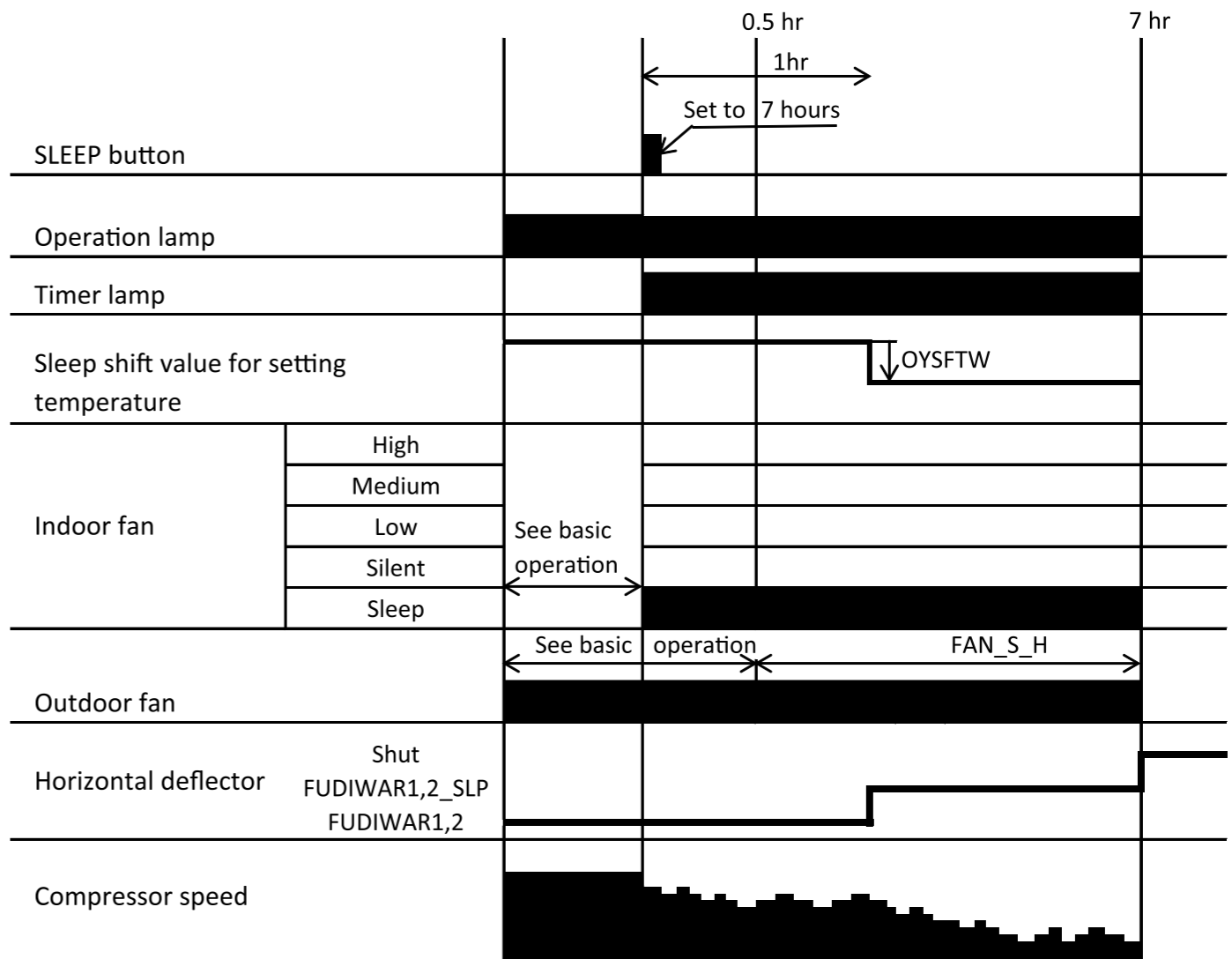

### Notes :

- (1) The sleep operation starts when the "SLEEP" button is pressed.
- (2) When the sleep operation is set, the maximum compressor speed is limited to WSZMAX, and the indoor fan set is "sleep"(FWSOY\_P).
- (3) The indoor fan speed does not change even when the fan speed mode is changed.
- (4) If sleep operation is canceled by the cancel button or sleep button, all data is cleared.
- (5) 1 hour after the sleep operation is set, the sleep shift value(OYSFTW) is reduced.



## Heating Powerful Operation

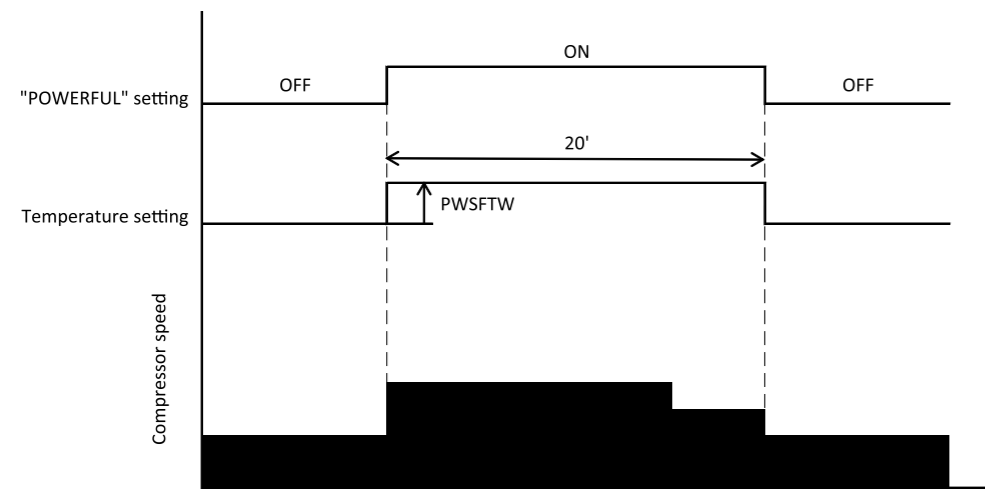

### Notes :

- (1) Pressing the "POWERFUL" button will reduce the temperature setting by PWSFTW.
- (2) The powerful operation is for 20 minutes after setting.
- (3) Operation is continued forcibly thermo-ON for 20 minutes after the powerful operation is finished.
- (4) Defrost is inhibited for 20 minutes after the start of the powerful operation.
- (5) Pressing the "START/STOP" button and "POWERFUL" button during powerful operation will cancel the powerful operation.
- (6) If the sleep timer is set during powerful operation, the powerful operation will be canceled.
- (7) If the fan speed of the remote controller is set to "AUTO" or "HIGH", the compressor's maximum speed during powerful operation will be set to WMAX2. The lower limit speed is WKYMIN\_PW.
- (8) If the fan speed of the remote controller is set to "MED", the compressor's maximum speed during powerful operation will be set to WJMAX\_PW. The lower limit speed is WJMIN\_PW.
- (9) If the fan speed of the remote controller is set to "LOW", the compressor's maximum speed during powerful operation will be set to WBEMAX\_PW. The lower limit speed is WBEMIN\_PW.
- (10) If the fan speed of the remote controller is set to "SILENT", the compressor's maximum speed during powerful operation will be set to WSZMAX\_PW. The lower limit speed is WSZMIN\_PW.
- (11) The fan speed increases by FNUPPW\_W.

## Clean Operation

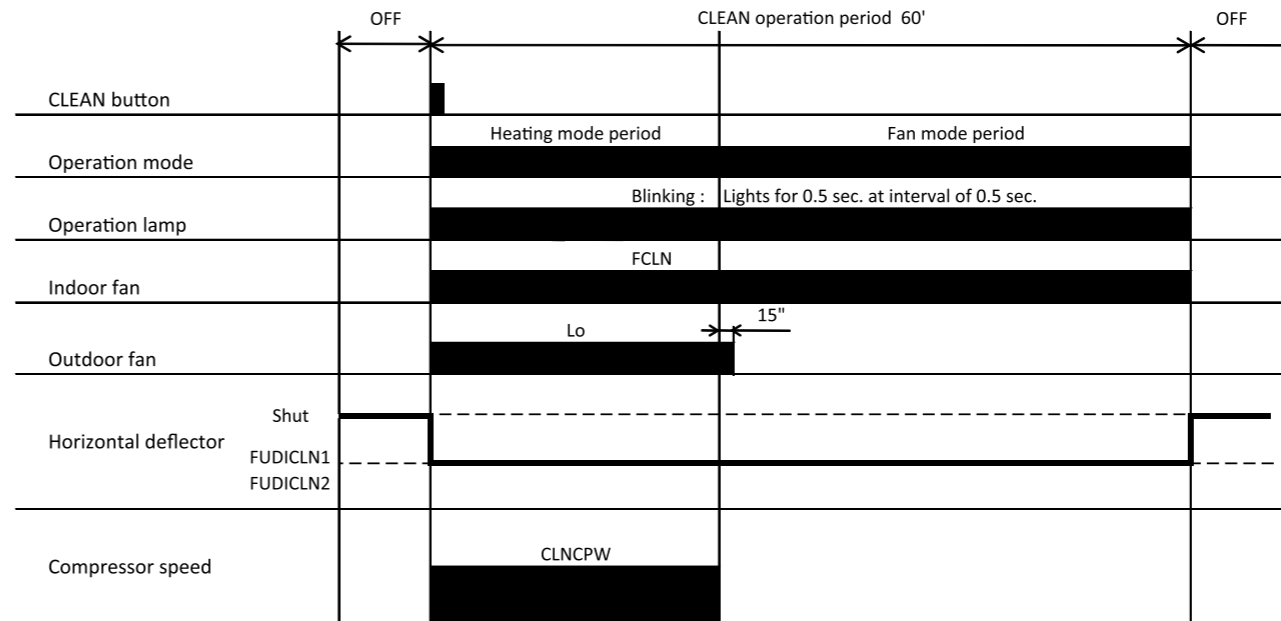

### Notes :

- (1) During CLEAN operation period, heating mode will change to fan mode when HEX temperature is "CLNEVP" or more except for 3 minutes operation.
- (2) For multi connections, CLEAN operation is limited to fan mode.

## Leave Home

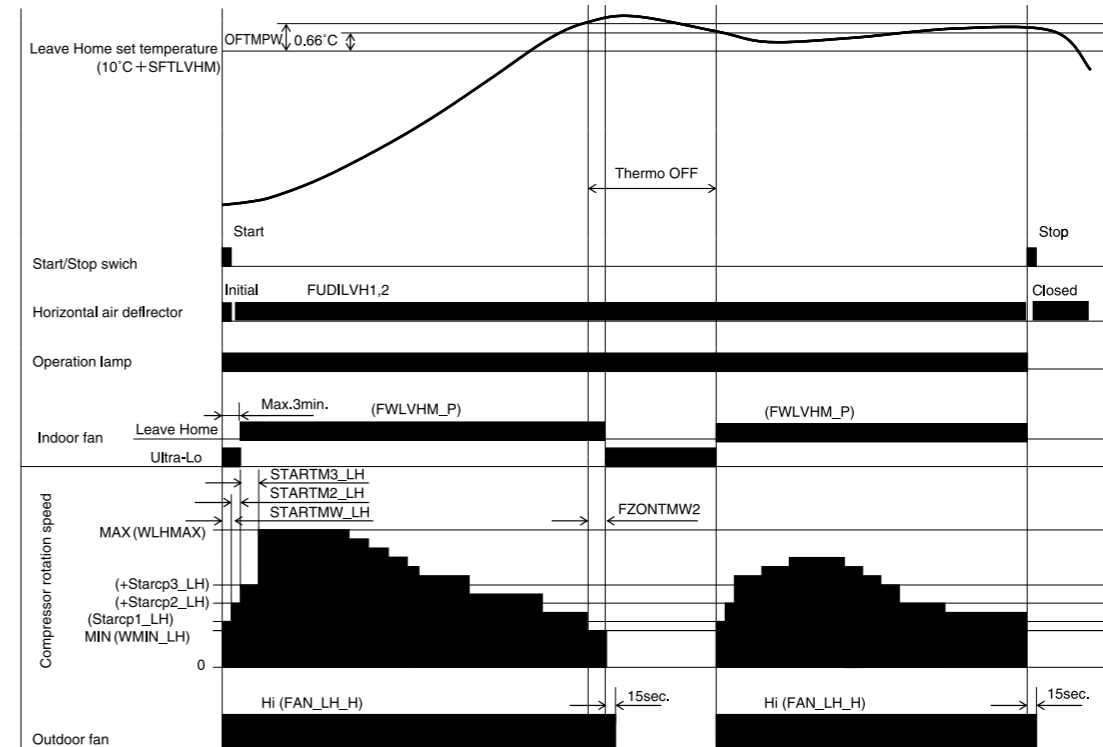

### Notes:

Perform Leave Home operation according to the following control contents.

- ① Operation mode : Heating
  - ② Temperature set : 10°C
  - ③ Temperature setting correction shift : + 『SFTLVHM』
  - ④ Indoor fan : 『FWLVHM\_P』
  - ⑤ Outdoor fan : 『FAN\_LH\_H』
  - ⑥ Compressor start control : Set the start control using the special value for the Leave Home mode.
  - ⑦ Compressor rotation speed : Upper limit speed by fuzzy control 『WLHMAX』  
Lower limit speed by fuzzy control 『WMIN\_LH』
  - ⑧ Operation lamp : The timer lamp lights up when the timer for the desired number of days is set.
- ※ The vertical air deflection plate is initially operated when the Leave Home mode is activated; this serves as a notification that the Leave Home mode has been set.

# REFRIGERATING CYCLE DIAGRAM

MODEL RAK-60PPA/RAC-60WPA

COOLING, DEHUMIDIFYING, DEFROSTING

OUTDOOR UNIT

INDOOR UNIT

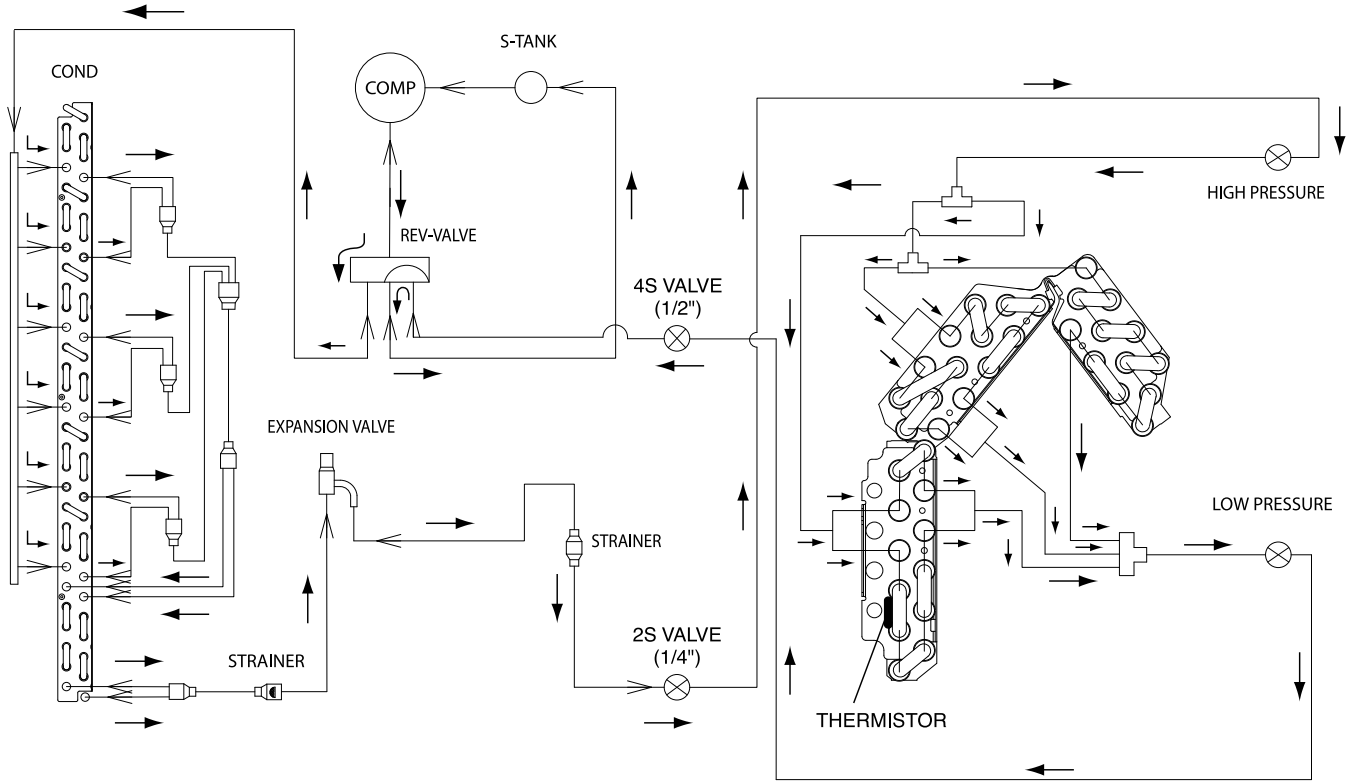

HEATING

OUTDOOR UNIT

INDOOR UNIT

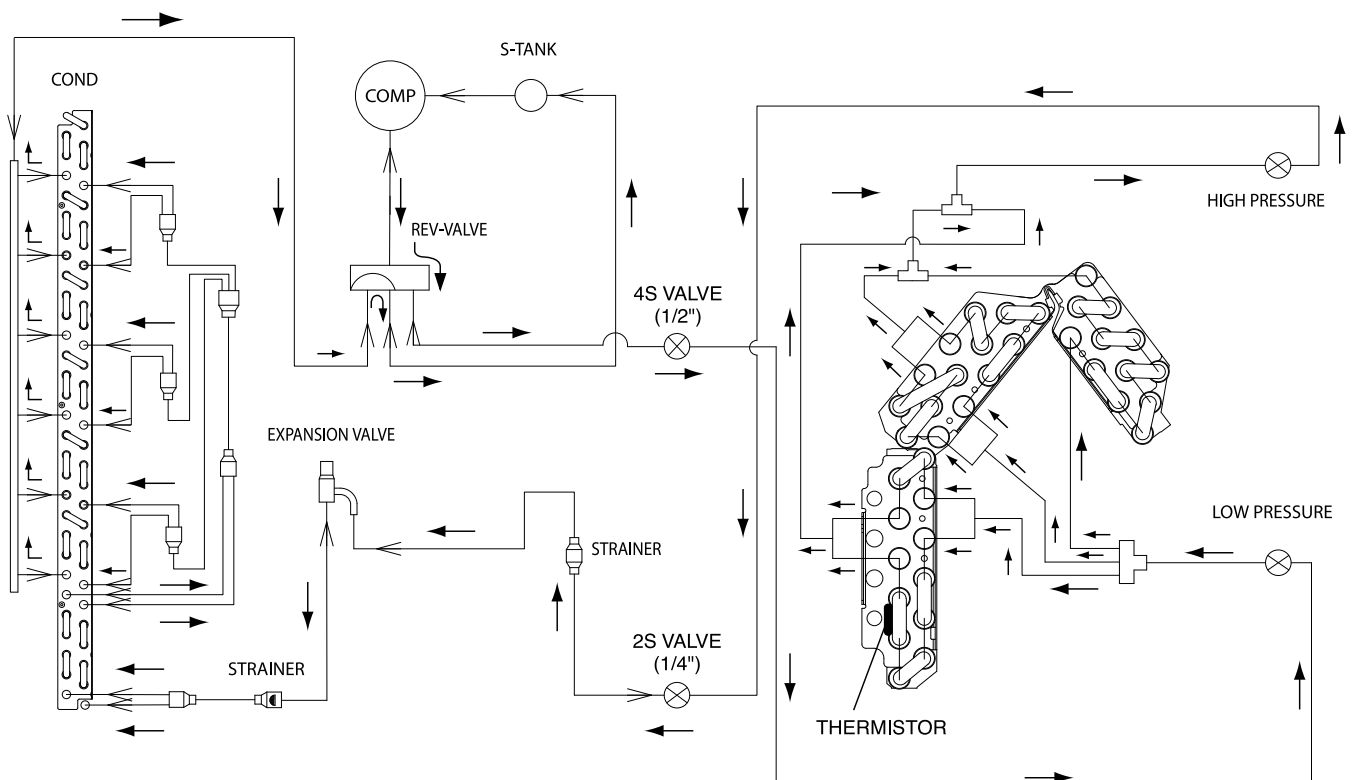

## AUTO SWING FUNCTION

INPUT SIGNAL	OPERATION	PRESENT CONDITION		OPERATING SPECIFICATION	REFERENCE
		OPERATION MODE	AIR DEFLECTOR		
KEY INPUT	STOP	EACH MODE	STOP	ONE SWING (CLOSING AIR DEFLECTOR) ① DOWNWARD ② UPWARD	INITIALIZE AT NEXT OPERATION.
	DURING OPERATION	AUTO COOL COOL FAN AUTO DRY DRY	DURING ONE SWING	STOP AT THE MOMENT.	
			STOP	START SWINGING ① DOWNWARD ② UPWARD ③ DOWNWARD	
		AUTO HEAT HEAT CIRCULATOR	DURING SWINGING	STOP AT THE MOMENT.	
			STOP	START SWINGING ① DOWNWARD ② UPWARD ③ DOWNWARD	
			DURING SWINGING	STOP AT THE MOMENT.	
THERMO. ON (INTERNAL FAN ON)		AUTO DRY DRY	TEMPORARY STOP	START SWING AGAIN.	
THERMO. ON (INTERNAL FAN OFF)	DURING OPERATION	AUTO HEAT HEAT CIRCULATOR	DURING SWINGING	STOP SWINGING TEMPORARILY. (SWING MODE IS CLEARED IF SWING COMMAND IS TRANSMITTED DURING TEMPORARY STOP.)	
MAIN SWITCH ON	STOP	COOL FAN DRY	STOP DURING ONE SWING	INITIALIZE ① DOWNWARD ② UPWARD	
		HEAT CIRCULATOR	STOP DURING ONE SWING	INITIALIZE ① DOWNWARD	
MAIN SWITCH OFF	DURING OPERATION	EACH MODE	STOP DURING SWINGING	ONE SWING (CLOSING AIR DEFLECTOR) ① DOWNWARD ② UPWARD	INITIALIZE AT NEXT OPERATION.
			DURING INITIALIZING		
CHANGE OF OPERATION	DURING OPERATION	EACH MODE	STOP	INITIALIZING CONDITION OF EACH MODE.	
			DURING SWINGING	STOP SWINGING AND MODE BECOMES INITIALIZING CONDITION.	

# DESCRIPTION OF MAIN CIRCUIT OPERATION

MODEL RAK-60PPA

## 1. Reset Circuit

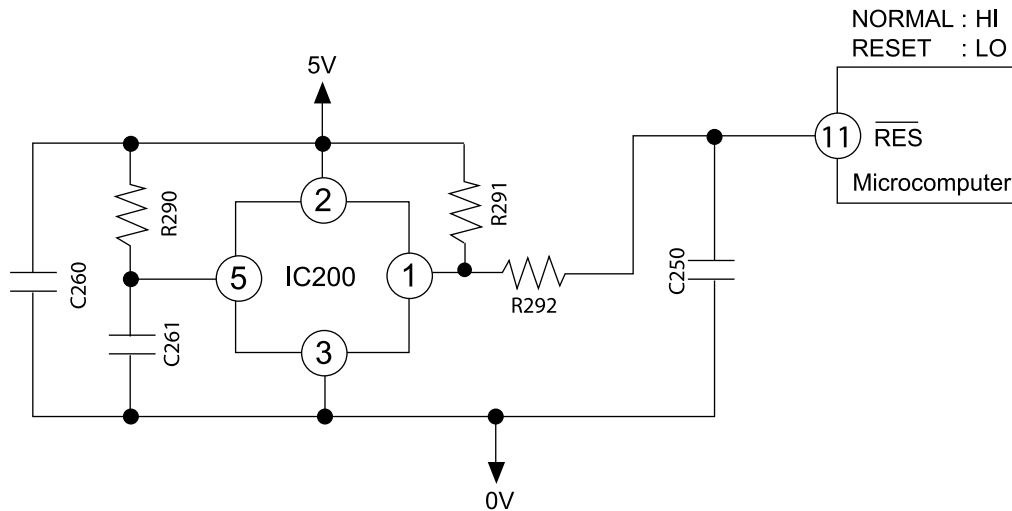

Fig. 1-1

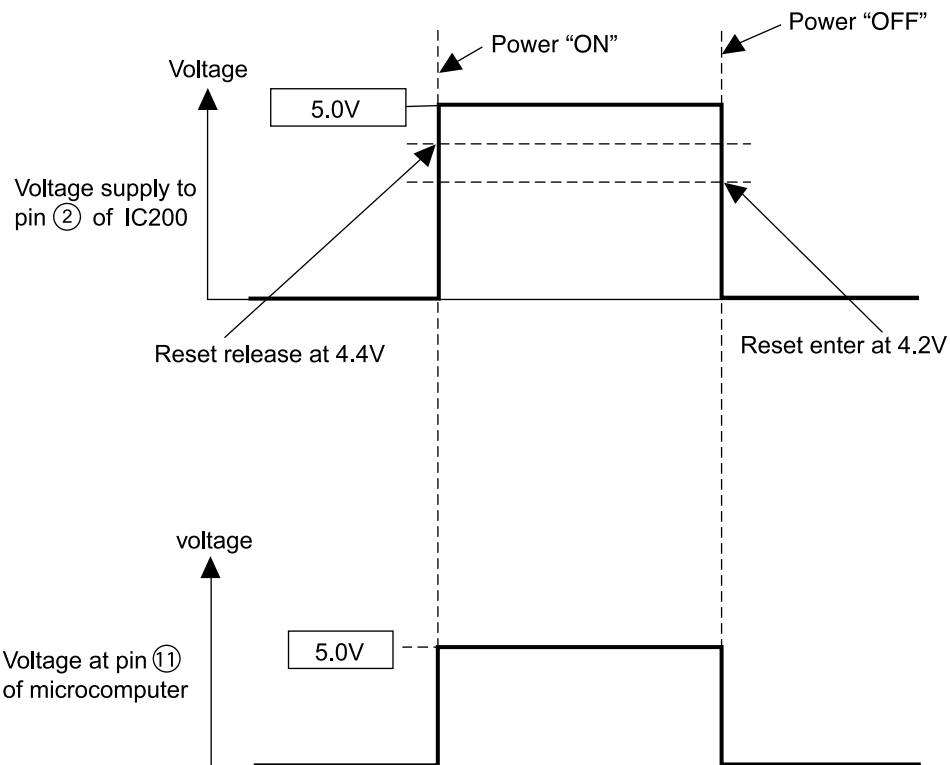
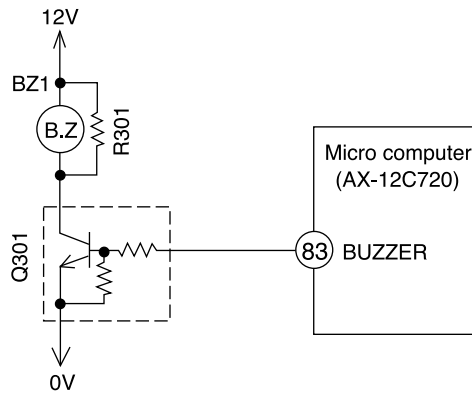

Fig. 1-2

- The reset circuit initializes the microcomputer program when power is ON or OFF.
- Low voltage at pin 11 resets the microcomputer and Hi activates the microcomputer.
- When power "ON" 5V voltage rises and reaches 4.4V, pin 1 of IC200 is set to "Hi". At this time the microcomputer starts operation.
- When power "OFF" voltage drops and reaches 4.2V, pin 1 of IC200 is set to "Low". This will RESET the microcomputer.

## 2. Buzzer Circuit



When the buzzer is to be activated, buzzer output pin 83 of the micro computer alternates between ON and OFF repeatedly at 4kHz and Q301 is turned ON/OFF accordingly. A 4kHz voltage is applied to the buzzer and the diaphragm of the buzzer vibrates to output 4kHz sound.

## 3. Initial setting (IC401)

The pre-heating operation start value, ratings of the compressor, maximum rotation speed, etc. are preset in the micro computer.

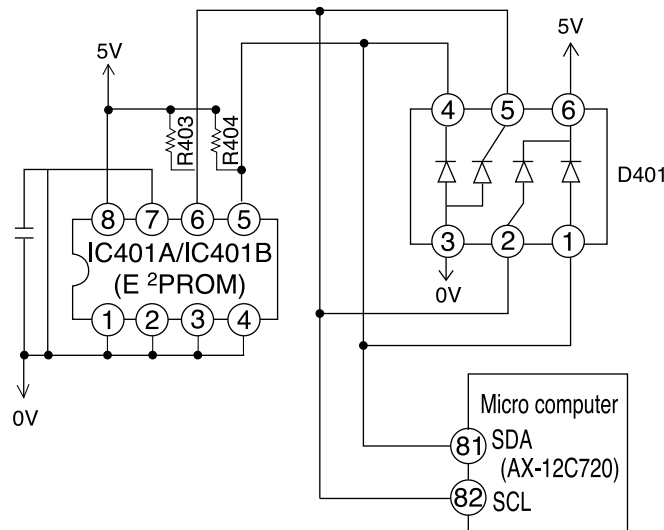

## 4. Receiver Circuit

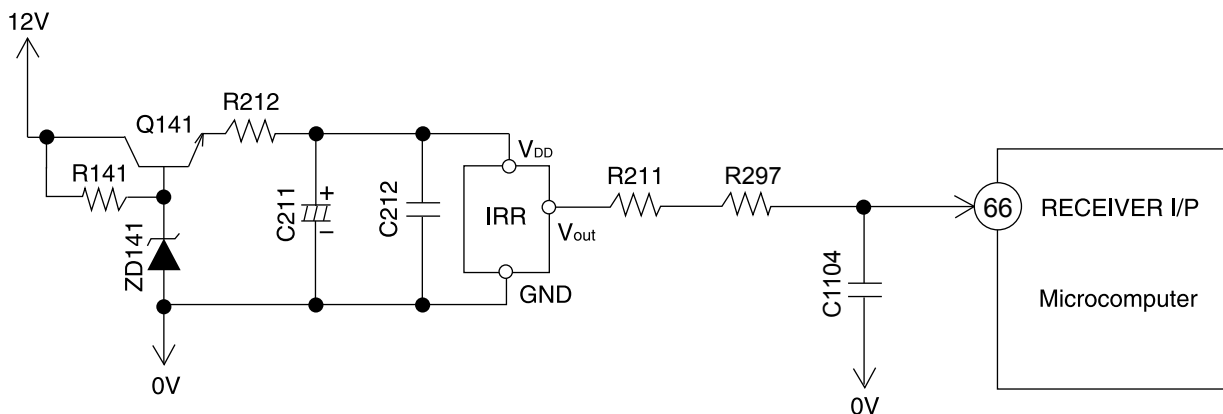

- The light receiver unit receives the infrared signal from the wireless remote control. The receiver amplifies and shapes the signal and outputs it.

## 5. Auto Sweep Motor Circuit

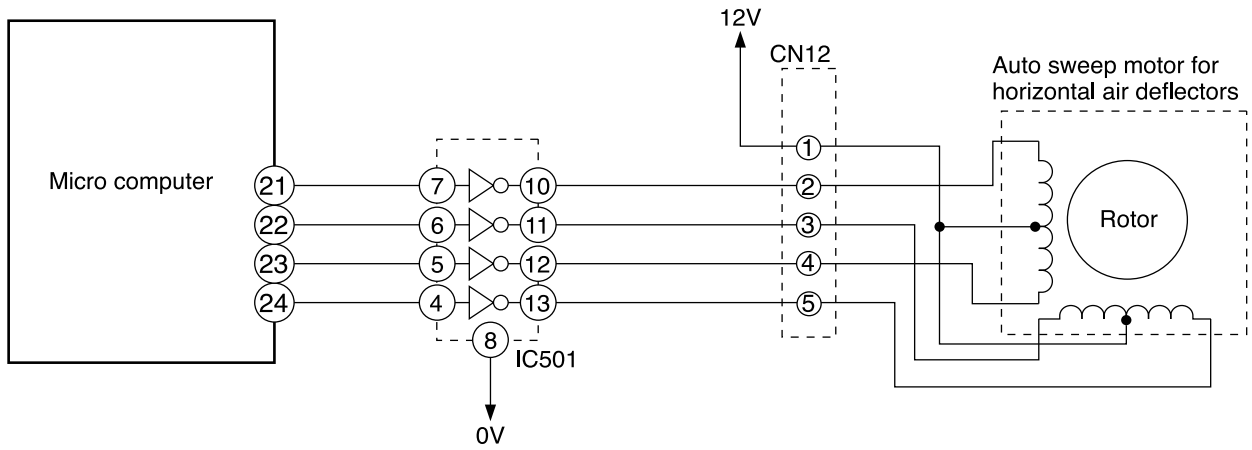

Fig. 5-1 Auto Sweep Motor Circuit (Horizontal air deflectors)

- Fig. 5-1 shows the Auto sweep motor drive circuit; the signals shown in Fig. 5-2 are output from pins ⑮ – ⑱ of the micro computer.

Micro computer pins	Step width						Horizontal air deflectors: 10ms.	
Horizontal air deflectors	1	2	3	4	5	6	7	8
⑳	[Active]			[Inactive]				
㉑	[Active]	[Inactive]				[Active]		
㉒	[Inactive]				[Active]			
㉓	[Inactive]		[Active]			[Inactive]		

Fig. 5-2 Micro computer Output Signals

- As the micro computer's outputs change as shown in Fig. 5-2, the core of the auto sweep motor is excited to turn the rotor. Table 5-1 shows the rotation angle of horizontal air deflectors.

Table 5-1 Auto sweep Motor Rotation

	Rotation angle per step (°)	Time per step (ms)
Horizontal air deflectors	0.0879	10

## 6. Room Temperature Thermistor Circuit

- Fig. 6-1 shows the room temperature thermistor circuit.

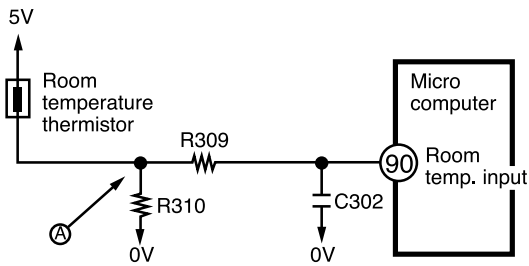

Fig. 6-1

- The voltage at (A) depends on the room temperature as shown in Fig. 6-2.

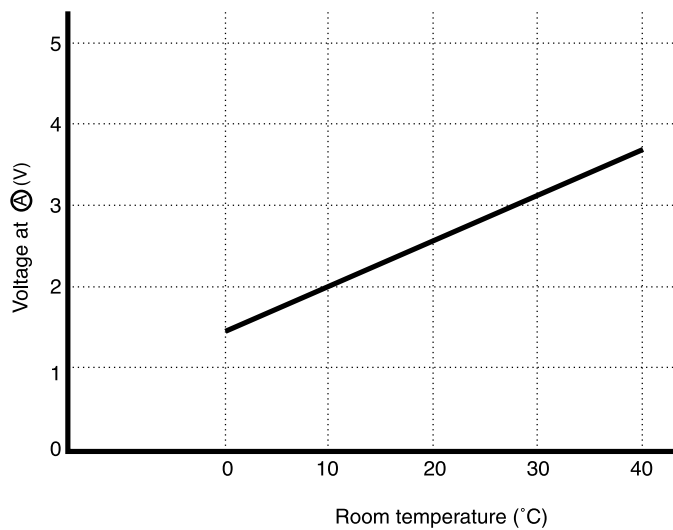

Fig. 6-2

## 7. Heat exchanger temperature thermistor circuit

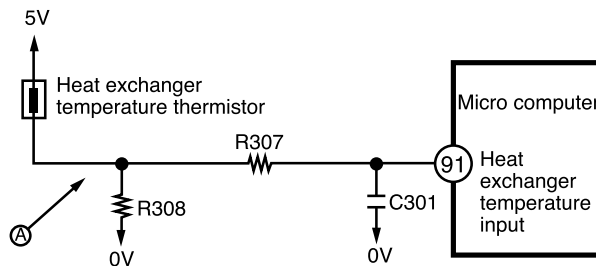

Fig. 7-1

- The circuit detects the indoor heat exchanger temperature and controls the following.

(1) Low-temperature defrosting during cooling and dehumidifying operation.

The voltage at (A) depends on the heat exchanger temperature as shown in Fig. 7-2.

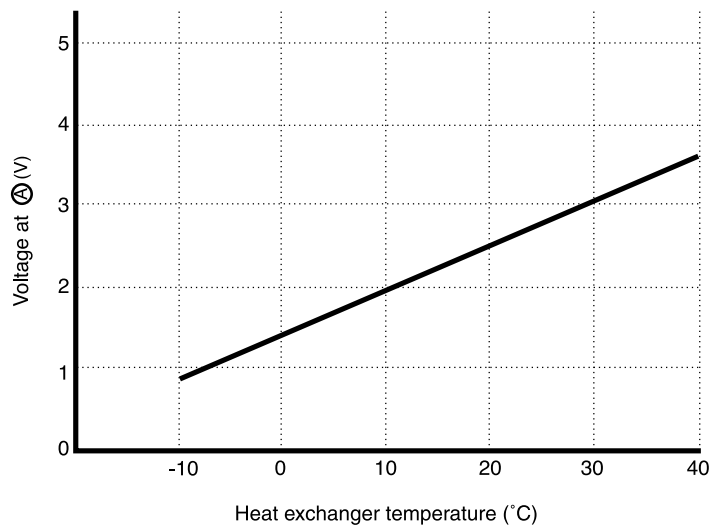

Fig. 7-2

## 8. Temporary Switch

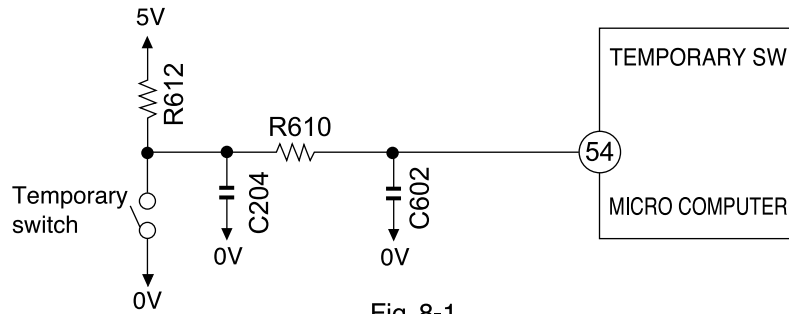

Fig. 8-1

- The temporary switch is used to operate the air conditioner temporarily when the wireless remote control is lost or faulty.
- The air conditioner operates in the previous mode at the previously set temperature. However, when the power switch is set to OFF, it starts automatic operation.

## 9. Indoor Fan Motor Feedback Circuit

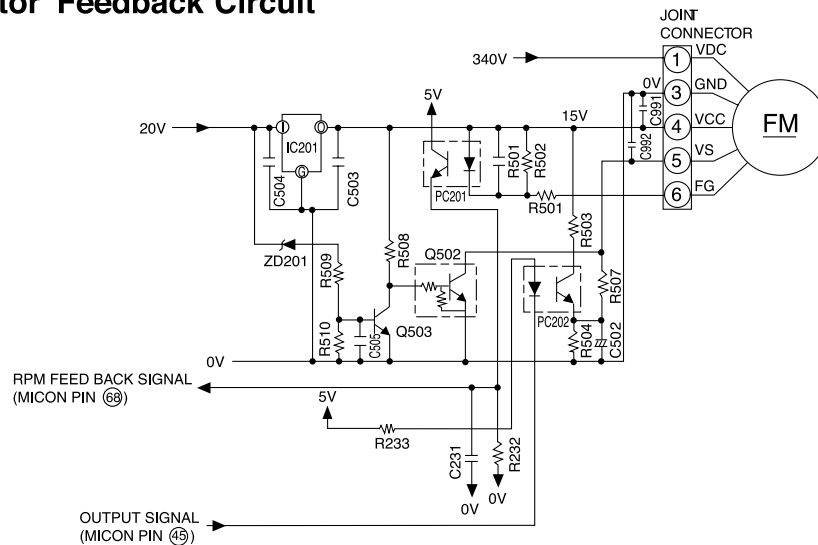

Fig. 9-1

- <Exp. of circuit wave>

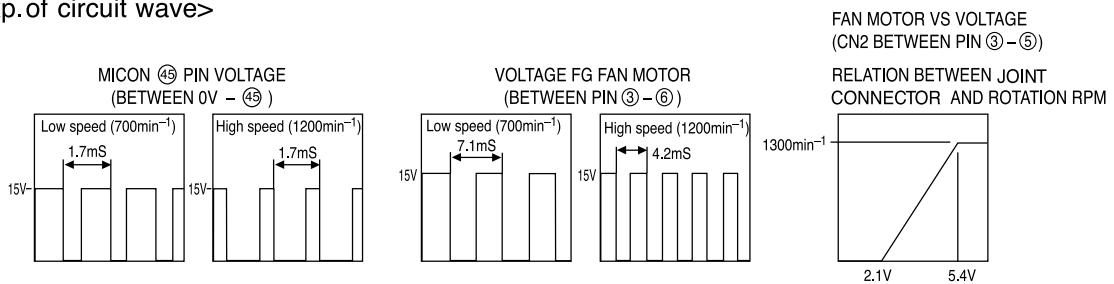

Fig. 9-2

- Fan motor will receive signal thru Joint Connector with VDC (Motor Drive Voltage), VCC (Motor Controller Power Supply), VSC (RPM Instruction) motor WCC return the FG signal under frequency RPM.
- The circuit produces fan motor drive from 340VDC supplied from the indoor unit and controls the fan motor speed.

### ⚠ CAUTION 1

Indoor fan motor circuit will be connected with primary power source line and please take care of the electrical shock.

### ⚠ CAUTION 2

Please do not disconnect the fan motor connector during running due to the high voltage supply, it will cause the damage at fan motor and PWB.



## 10. Dip-switch

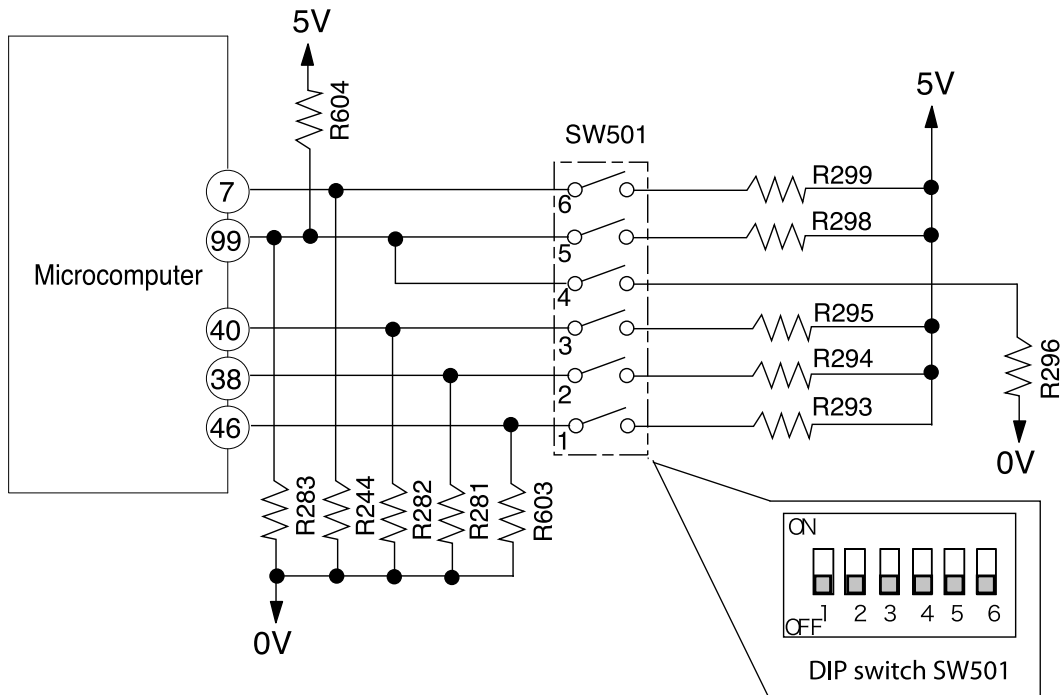

Fig. 10-1 Dip switch Circuit

- Fig. 10-1 shows the dip switch circuit; the table shown in Fig. 10-2 are function and setting position from ①–⑥ of the switch no.

Switch No.	FUNCTION	Switch Position/Setting.					
1	AUTO RESTART	OFF*	ENABLE	ON	DISABLE	-----	
2	CARD KEY MODE	OFF*	DISABLE	ON	ENABLE	-----	
3	CARD KEY LOGIC SELECT	OFF*	INPUT HIGH ACTIVE	ON	INPUT LOW ACTIVE	-----	
4	HEATING/COOLING ONLY MODE SELECT	OFF*	NORMAL (HEAT AND COOL)	OFF	HEATING ONLY	ON	COOLING ONLY
5	HEATING/COOLING ONLY MODE SELECT	OFF*		ON		OFF	
6	REMOCON ID SELECT ※1	OFF*	SELECT ID A	ON	SELECT ID B	-----	

Fig. 10-2 Functions of Dip switch

NOTE:

※ Marking is position of shipping [FACTORY default setting]

※ 1 Weekly Timer wireless remocon for new model have function of setting remocon ID A or B. This remocon using model can not operate "DIP SWITCH 6" (disabled by EEPROM data flag.)

- If the dip switch is set to "Heating mode only" or "Cooling mode only", the wireless remote controller must be set to operation mode lock setting as indicated on page 113.

# DESCRIPTION OF MAIN CIRCUIT OPERATION

## 1. Power Circuit

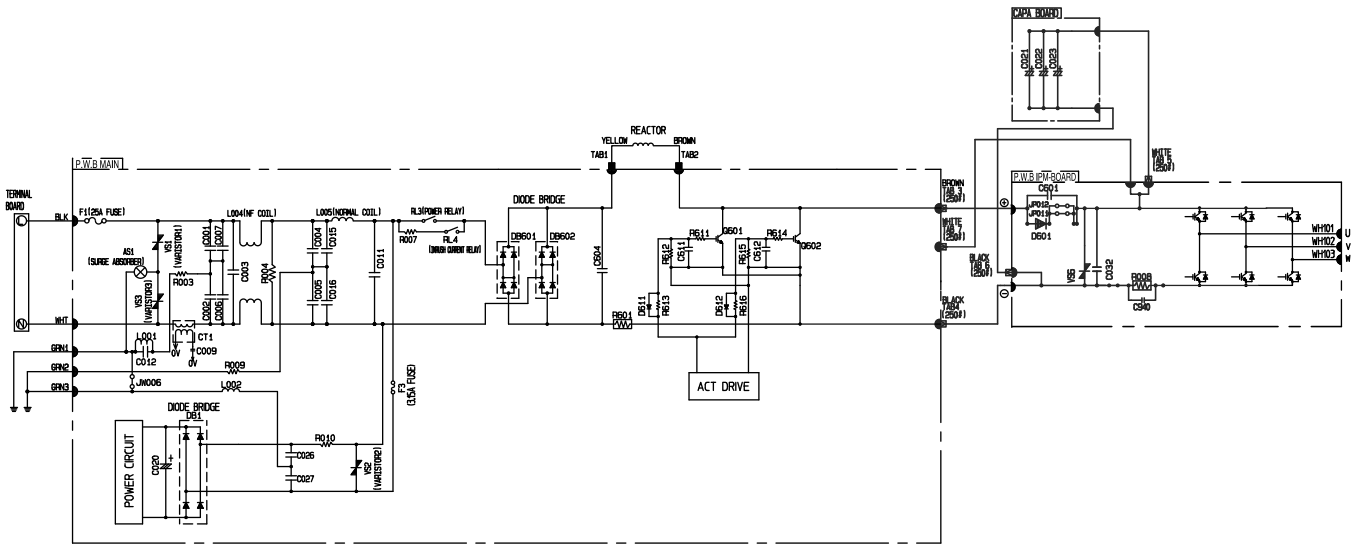

Fig 1-1

※ This circuit full-wave rectifies 220 - 240 VAC applied between terminals L and N and boosts it to a required voltage with the IPM to create a DC voltage.

The voltage become 320-360V when the compressor is operated.

※ Importance component

( 1 ) Intelligence Power Module (IPM)

A module that constitute by an inverter part.

( 2 ) Diode Stack (DB1, DB601, DB602)

These rectify the 220 - 240 VAC from terminal L and N to a DC power supply.

<Reference>

※ In case of Intelligence Power Module malfunction or connection failure immediately after compressor starts, its may stop due to error of [abnormal low speed],[switching failure],[Ip stop] and others.

<Reference>

※ If diode stack (DB601,DB602) are faulty, DC voltage may not be generated and the compressor may not operate at all. Also be aware that the 3.15A fuse might have blown.

(3) Smoothing capacitors (C021~C024, 400  $\mu$ F, 450V)

This smoothes (averages) the voltage rectified by the diode stack.

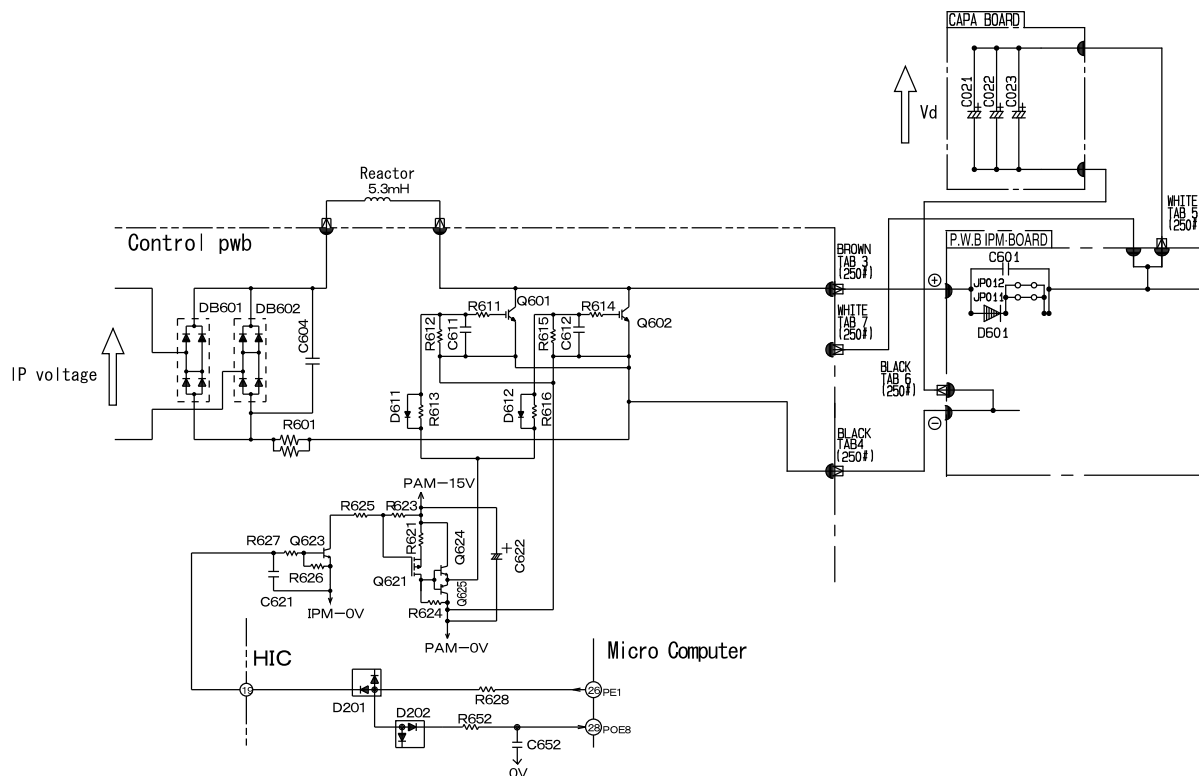

Fig. 1-2



图1-3

(4) IGBT to improve efficiency (Q601, Q602)

It will improve the efficiency during compressor load become heavy when current flow thru the chopper period of Q601, Q602.

(5) C001 ~ C007, C015, C016, C026, C027, L004, L005

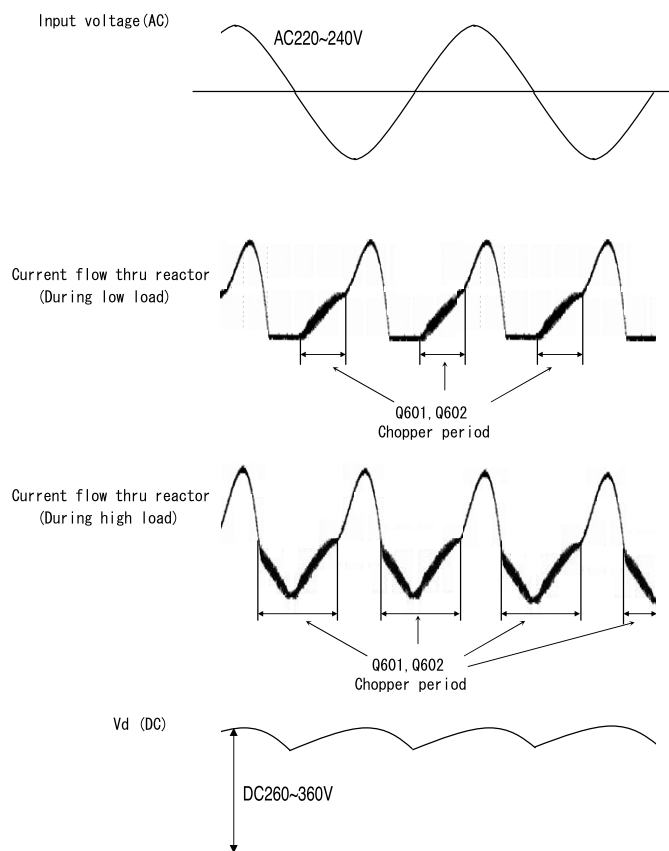
These absorb electrical noise generated during operation of compressor and also absorb external noise entering from power line to protect electronic parts.

(6) Surge Absorber, Varistor1, 2, 3

These absorb external power surge.

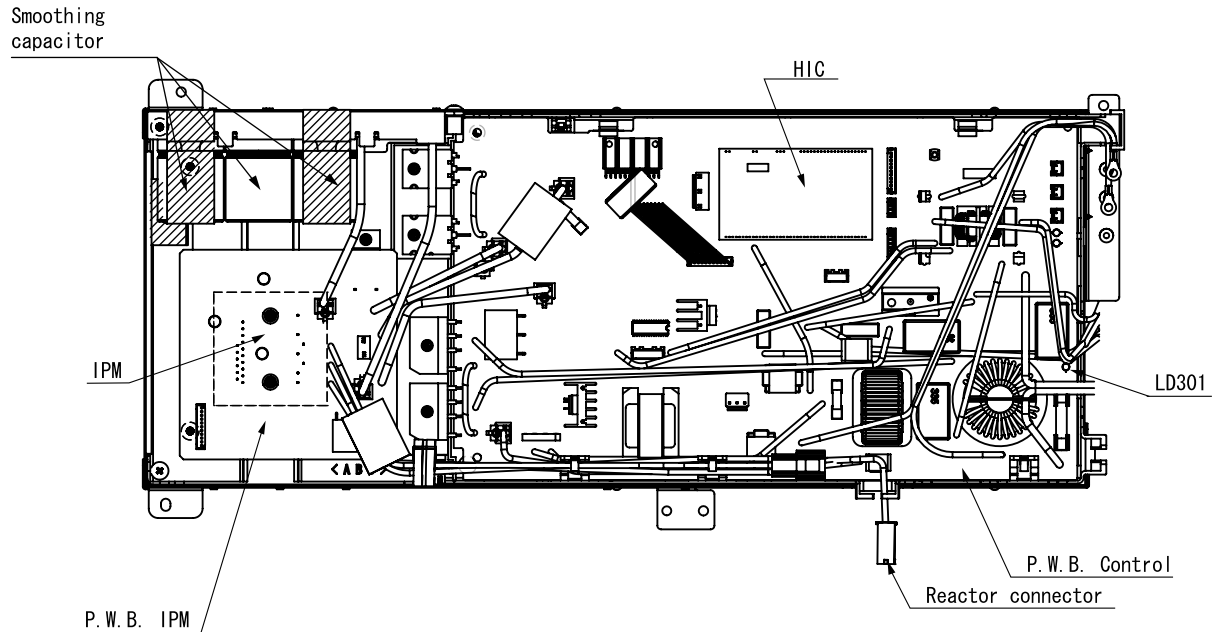

※Be careful to avoid an electric shock as a high voltage is generated. Also take care not to cause a short-circuit through incorrect connection of test equipment terminals. The circuit board can be damage.

## 2. PWB for power circuit

Voltage specification of power circuit as shown in below table.

<Checking point>

Output	Spec	Main load	Measuring point	Example of possible failure mode.
5V O/P	$5 \pm 0.4V$	Micon, Thermistor	Tester⊕ : J19 (5V) Tester⊖ : J16 (0V)	Outdoor not operate, no blinking indication
12V O/P	$12 \pm 1V$	Micon, IC2, 3, 4 Relay circuit	Tester⊕ : L104(12V) Tester⊖ : J16 (0V)	Outdoor not operate, no blinking indication
16V O/P	$15.5 \pm 1.5V$	IPM for Comp IPM for DC fan	Tester⊕ : L103(16V) Tester⊖ : J16 (0V)	Stop : LD301 3,4 or 12 times blinking
PAM-15V O/P	$15 \pm 1.55V$	ACT circuit	Tester⊕ : J31 (PAM-15V) Tester⊖ : J16 (0V)	Stop : LD301 14 times blinking

※ Power circuit for pwb can consider normal if the result is satisfied with above specification.

### 3. Reversing valve control circuit

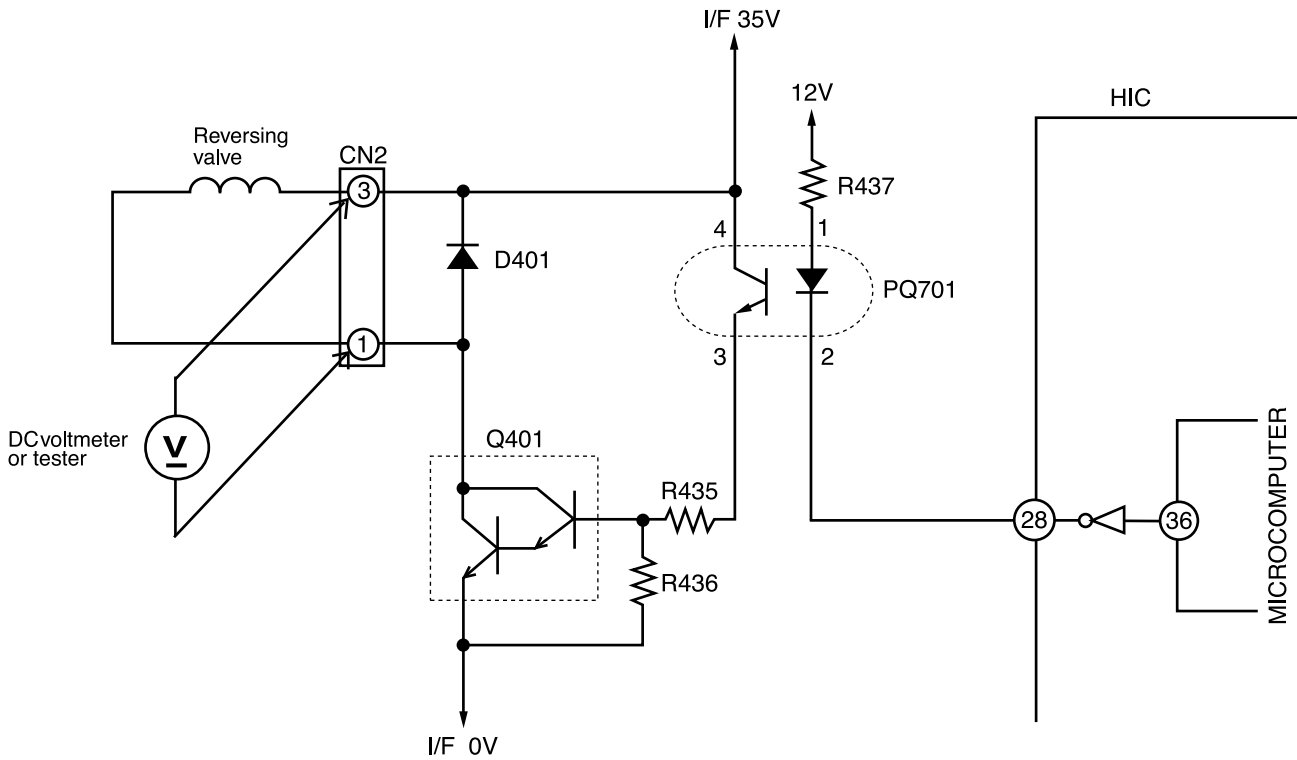

Fig. 3 – 1

- Reversing valve control circuit can switch reversing valve ON/OFF according to instruction from indoor microcomputer depending on the operation condition shows in Table 3-1.

Voltage at each point in each operation condition is approximately as shown below when measured by tester. (When voltage between pin 1 and 3 CN2 is measured)

Table 3-1

Operation condition		Voltage between pin 1 and 3 CN2
Cooling	General operation of Cooling	About 0V
Heating	In normal heating operation	About 35V
	MAX. rotation speed instructed by indoor microcomputer after defrost is completed	About 35V
	Defrosting	About 0V
Dehumidifying	Sensor dry	About 0V

## 4. Temperature Detection Circuit

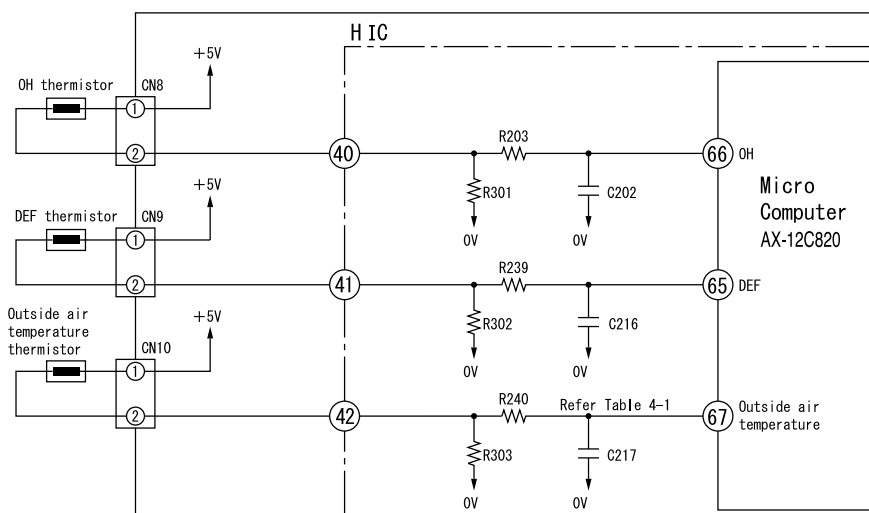

Fig. 4-1

- \* OH thermistor circuit detect the temperature at the surface of compressor head, DEF thermistor circuit detect the defrosting operation temperature.
  - \* A thermistor is a negative resistor element which has characteristics that the higher (lower) the temperature, the lower (higher) the resistance.
  - \* When the compressor is heated, the resistance of the OH thermistor becomes low and  $\oplus 5V$  is divided by OH thermistor and R301 and the voltage at pin 66 of microcomputer.
  - \* Compare the voltage at microcomputer pin 66 and setting value stored inside. If the value exceed the set value, microcomputer will judge that the compressor is overheated and stop the operation.
  - \* When frost is formed on the outdoor heat exchanger, the temperature at the exchanger drops abruptly. Therefore the resistance of the DEF thermistor becomes high and the voltage at pin 65 of micro computer drops. If this voltage becomes lower than the set value stored inside, microcomputer will enter the defrost control.
  - \* During defrost operation, the microcomputer will transfer the defrosting condition command to indoor unit via SDO pin of interface of IF transmission output.
  - \* The microcomputer read the outdoor temperature by Outside Air thermistor and transfer it to the indoor unit, thus controlling the compressor rotation speed according to the set value in the EEPROM of indoor unit and switching the operation mode (outdoor fan on/off etc.) to DRY mode.
- Below table show the typical values of outdoor temperature in relation to the voltage.

Table 4-1

Outside Air Temperature (°C)	-10	0	10	20	30	40
Voltage at both side of R303 (V)	1.19	1.69	2.23	2.75	3.22	3.62

<Reference>

When the thermistor is open, open condition or disconnect, microcomputer pin 65~67 are approx. 0V;

When thermistor is shorted, they are approx. 5V and LD301 will blink 7 times.

However, an error is detected when only the OH thermistor is shorted and will enter blinking mode after 12 minutes start the compressor operation.

## 5. Electric expansion valve circuit

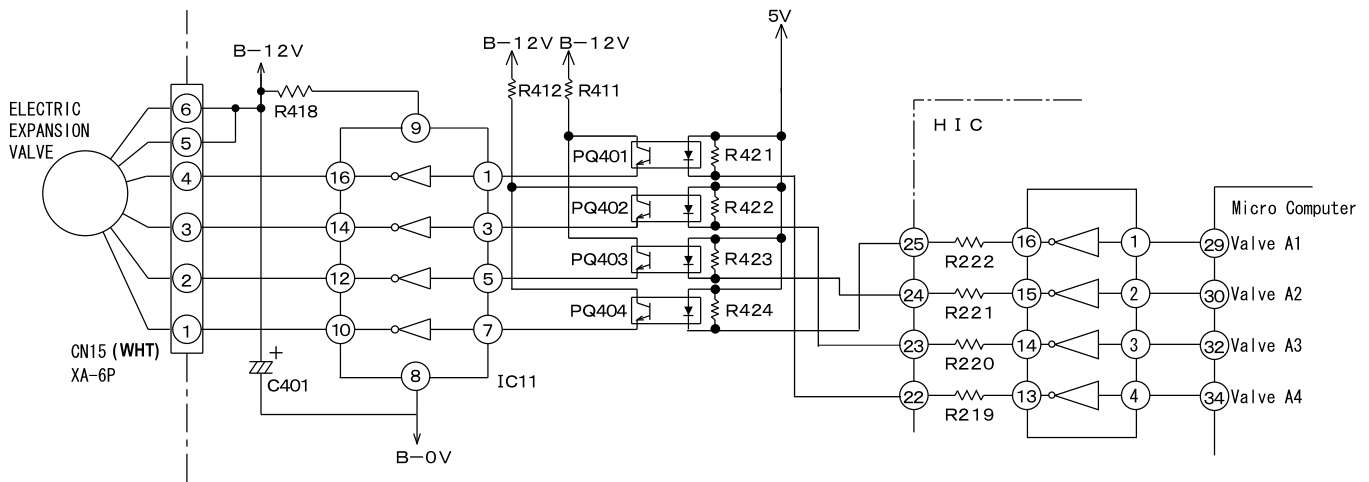

Fig.5-1

- \* The electric expansion valve is driven by DC12V. Power is supplied to 1 or 2 phases of 4-phase winding to switch magnetic pole of winding in order to control the opening degree.
- \* Relationship between power switching direction of phase and open/close direction is shown below. When power is supplied, voltages at pins 4 to 1 of CN15 are about 0.9V and 12V when no power is supplied. When power is reset, initial operation is performed for 10 or 20 seconds. During initial operation, measure all voltages at pin 4 to 1 of CN15 by using a multimeter. If there is any pin with voltage that has not changed from 0.9V or 12V, expansion valve or micro computer is broken.
- \* Fig.5-1 shows logic waveform when expansion valve is operating.

Table 5-1

CN15 pin no.	Wire	Drive status							
		1	2	3	4	5	6	7	8
①	WHT	ON	ON	OFF	OFF	OFF	OFF	OFF	ON
②	YEL	OFF	ON	ON	ON	OFF	OFF	OFF	OFF
③	ORN	OFF	OFF	OFF	ON	ON	ON	OFF	OFF
④	BLU	OFF	OFF	OFF	OFF	OFF	ON	ON	ON

Operation mode  
 1→2→3→4→5→6→7→8 VALVE CLOSE  
 8→7→6→5→4→3→2→1 VALVE OPEN

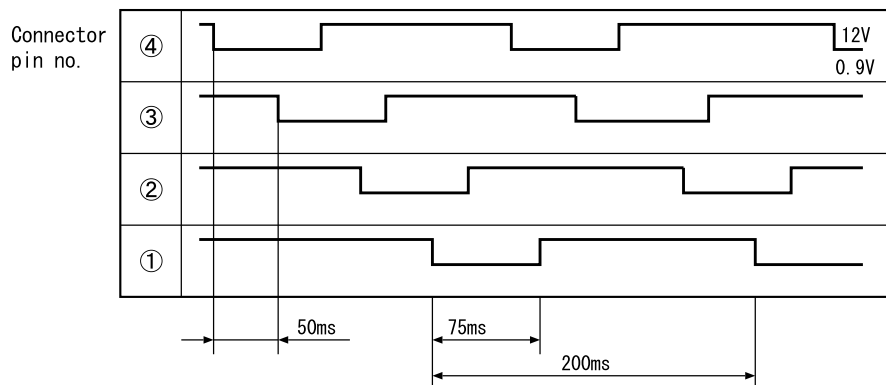

Fig.5-2

With expansion valve control, opening degree is adjusted to stabilize target temperature by detecting compressor head temperature. The period of control is about once per 20 seconds and output a few pulse.

## 6. Outdoor DC fan motor control circuit

\* This model is built with DC fan motor control circuit inside outdoor electrical unit.

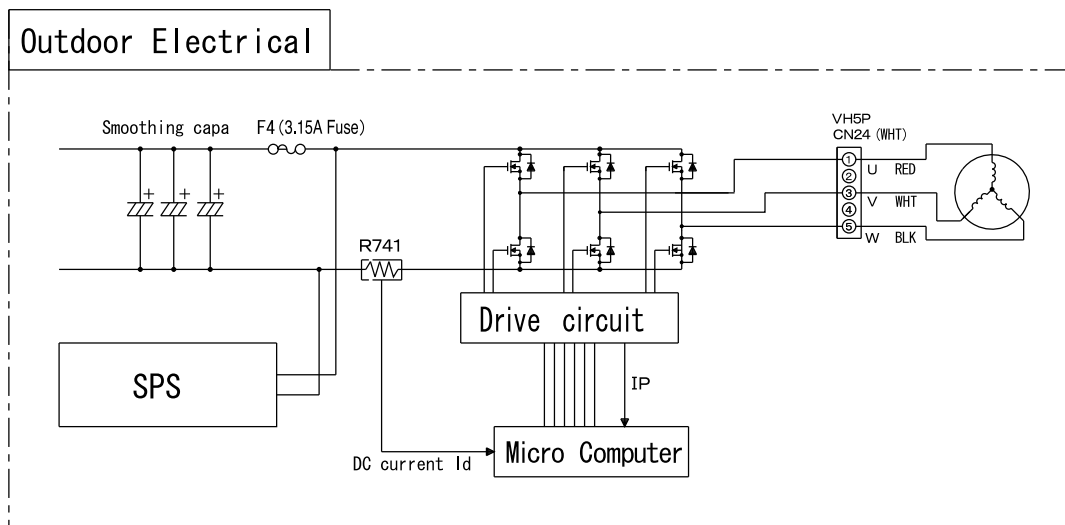

Fig 6—1

This DC fan motor is control by outdoor micro computer that follow the operating instruction received from indoor micro computer. The DC current that flow from R741 will presume actual operation speed and control the rotation to follow the operating instruction. Based on this DC current it will detect a over current and other fan motor failure.

### (1) Fan motor speed controller during starting

Due to the interference of strong wind etc., operation movement is changed based on fan direction and rotation speed as shown below during starting of operation.

In addition, the fair wind is define as wind that blow to outside direction using Mouth Ring part. At strong and contrary wind ... The rotational speed is not controlled as to protect the equipment and fan will rotate reversely depend on the wind. Automatically start when wind condition become weak.

At contrary wind ... The rotational speed is controlled in fair wind direction after it slowly reduce the speed and finally stop.

At fair wind ... The rotational speed is controlled as it is.

At strong fair wind ... The rotational speed is not controlled as to protect the equipment and fan will rotate reversely depend on the wind. Automatically start when wind condition become weak.

### (2) Fan motor speed controller during unit operating

There is a case where fan rpm is reducing during rotating caused by interference of strong wind. If this condition continue in long period, fan will stop rotating. (LD301 : 11 times blinking) The unit will restart according to control as per during start (1).



(3) Method of confirming self diagnosis LD301 lamp : 12 times blinking

If the unit stop and LD301 on the pwb blinking 12 times [fan lock stop is detected], follow below steps to confirm it.

1. Fan lock stop is detected when something has disturb the fan rotation by inserting material into propeller fan or ice has growing inside outdoor unit caused by snow.  
Remove it if found something is bloking the fan.
2. Confirmed that CN24 connector is securely inserted. Fan lock stop is detected also when connector is not properly inserted. Please securely insert if found any disconnection.
3. Fan lock stop also can be detected where strong wind blown surrounding the unit.  
Please confirm after restart the unit. (It may take few minutes to operate the compressor)  
It is not a malfunction of electrical unit or fan motor if the unit run continuesly after restart the unit.
4. Check fan motor condition as below procedure.

[Checking Fan Motor] procedure

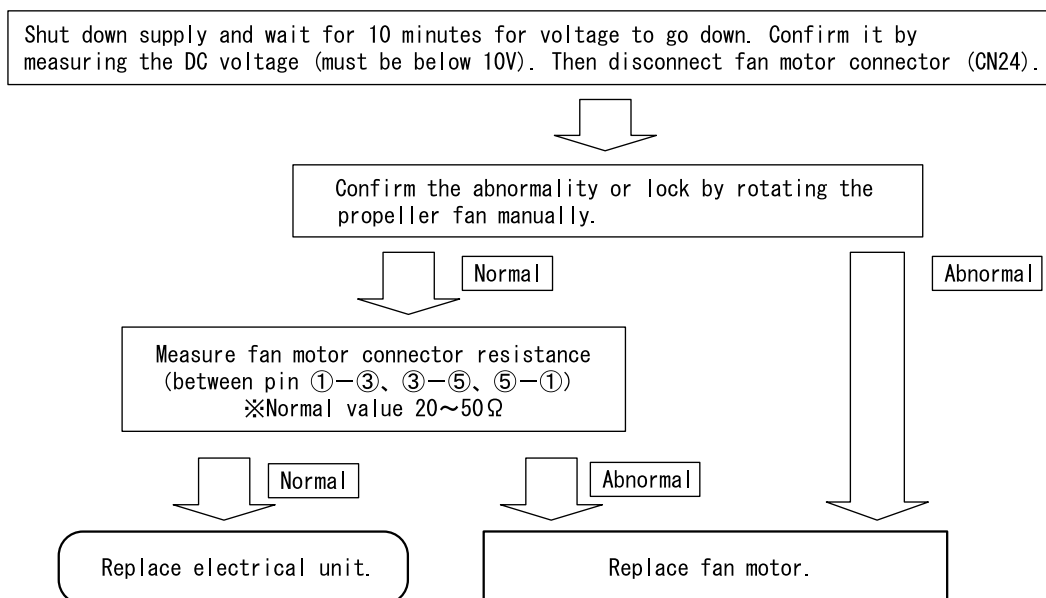

5. Reconnect again fan motor connector (CN24).

※ Please confirm above checking procedure if found F4(3.15A fuse) blown  
If fan motor is broken, replace both electrical unit and fan motor.

Reference

※ No power is supplied to the outdoor unit if F4(3.15A Fuse) is blown.  
Both DC fan motor and switching power supply is using same fuse.

Caution

※ Beware of electric shock due to high voltage when conducting an operation check.  
Power supply for DC fan motor and compressor is common (DC260~360V).

# SERVICE CALL Q & A

## COOLING MODE

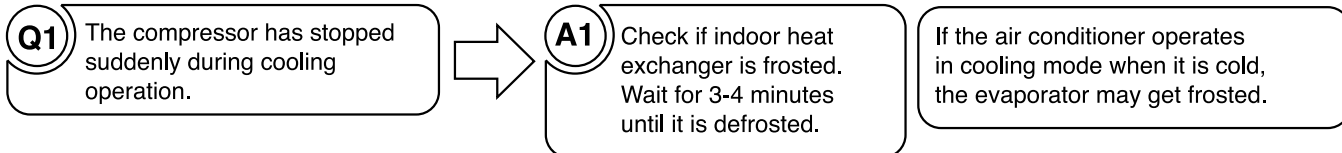

## DEHUMIDIFYING MODE

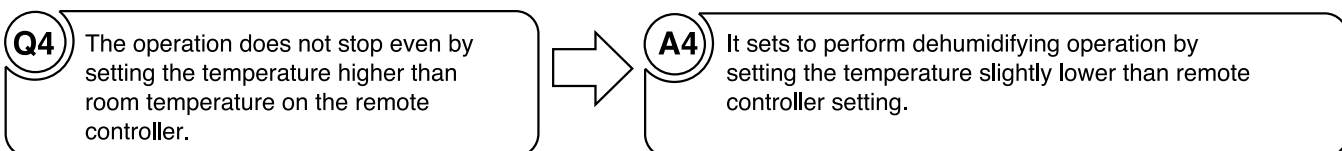
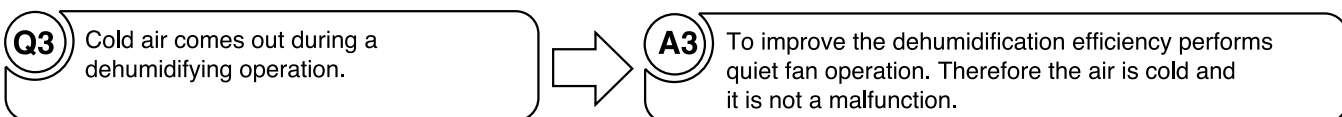
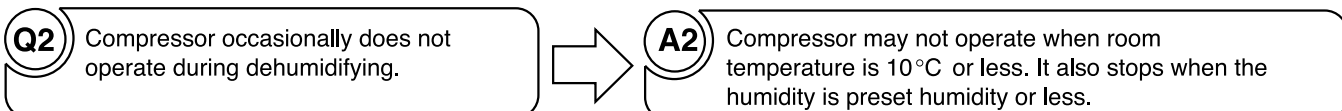
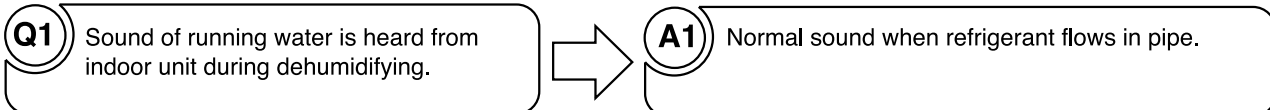

## HEATING MODE

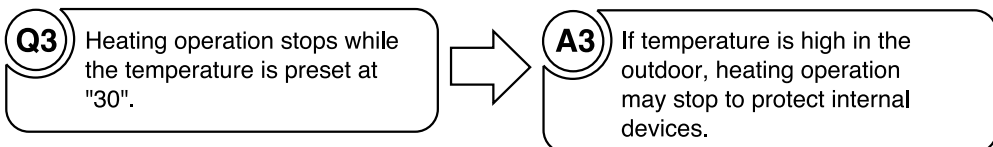
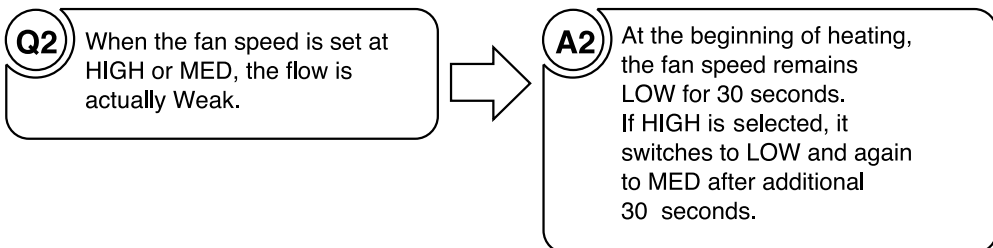
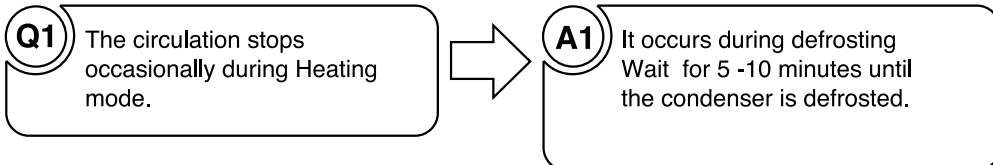

## AUTO FRESH DEFROSTING

**Q1** After the ON/OFF button is pressed to stop heating, the outdoor unit is still working with the OPERATION lamp lighting.



**A1** Auto Fresh Defrosting is carried out : the system checks the outdoor heat exchanger and defrosts it as necessary before stopping operation.

## AUTO OPERATION

**Q1** Fan speed does not change when fan speed selector is changed during auto operation.



**A1** At this point fan speed is automatic.

**Q2** How is the automatic operation mode determined?



**A2** According to the room temperature and outside temperature, heating or cooling operation is automatically selected. Refer to the basic operation section.

**Q3** The room temperature cannot be controlled at an automatic operation.



**A3** It is automatically set as follows.  
At cooling: and heating: Set at 22°C  
The room temperature setting can be raised 3°C by “^” or lowered 3°C by “v” .

## NICE TEMPERATURE RESERVATION

**Q1** When on-timer has been programmed, operation starts before the preset time has been reached.



**A1** This is because "Nice temperature reservation"function is operating. This function start operation earlier so the preset temperature is reached at the preset time. Operation may start maximum 60 minutes before the preset time.

**Q2** Does "Nice temperature reservation" function operate during dehumidifying?



**A2** It does not work. It works only during cooling and heating.

**Q3** Even if the same time is preset, the operation start time varies.



**A3** This is because "Nice temperature reservation"function is operating. The start time varies according to the load of room. Since load varies greatly during heating, the operation start time is corrected, so it will vary each day.

## AT STARTING OPERATION

**Q1** When only the power switch is turned on, the damper at the bottom air outlet moves even if the START/STOP button is not pressed.



**A1** To ensure correct opening and closing of the damper, the damper will move when power is turned on or the unit is to be operated in order to check its fully opened and closed positions.

**Q2** When the heating operation is started, the indoor fan does not start immediately and the damper at the bottom air outlet occasionally does not open.



**A2** This is because the preheating device is working. It will not start to drive the fan until the refrigerating cycle warms up and warm air blows. Wait for a while. The damper does not open either during preheating or for one minute after preheating is finished.

**Q3** When the unit built behind the gallery (lattice door) is to be started immediately after it has stopped, the unit occasionally will not start.



**A3** Such a phenomenon may occur with built-in installation where heat is likely to be stuffy. Install the unit as near to the lattice door as possible so that air is not short-circuited, or provide a partition between the unit and lattice door.

## OTHERS

**Q1** The indoor fan varies among high air flow, low air flow and breeze in the auto fan speed mode. (Heating operation)



**A1** This is because the cool wind prevention function is operating, and does not indicate a fault.

The heat exchanger temperature is sensed in the auto fan speed mode. When the temperature is low, the fan speed varies among high air flow, low air flow and breeze.

**Q2** Loud noise from the outdoor unit is heard when operation is started.



**A2** When operation is started, the compressor rotation speed goes to maximum to increase the heating or cooling capability, so noise becomes slightly louder. This does not indicate a fault.

**Q3** Noise from the outdoor unit occasionally changes.



**A3** The compressor rotation speed changes according to the difference between the thermostat set temperature and room temperature. This does not indicate a fault.

**Q4** There is a difference between the set temperature and room temperature.



**A4** There may be a difference between the set temperature and room temperature because of construction of room, air current, etc. Set the temperature at a comfortable level for the space.

- Q5** Air does not flow immediately after operation is started.
- A5** Preliminary operation is performed for one minute when the power switch is turned on and heating or dehumidifying is set. The operation lamp blinks during this time for heating. This does not indicate a fault.
- Q6** Mold in the room cannot be inhibited even after performing the air conditioner drying operation.
- A6** Air conditioner drying operation is to dry the interior of the indoor unit to inhibit the growth of mold. It is not to inhibit the mold growth in the room.
- Q7** The interior of the indoor unit seems to be still damp even after performing the air conditioner drying operation.
- A7** Condition of the interior of the indoor unit varies depending on usage of the unit and condition of the indoor unit. If it is not dried after the first try, perform the drying more than one time for better effect.
- Q8** Even if the air conditioner drying is performed using the remote controller during the unit operation or timer programming, the air conditioner drying operation does not start.
- A8** To perform the air conditioner drying, stop the unit operation or programming beforehand.
- Q9** The unit is operated after built-in installation (behind the lattice door). It turns off for a long time and the room is not warmed (cooled).
- A9** Check to see if warm (cool) air is being short-circuited behind the lattice door. A short-circuit is likely to occur when the deflector position is not appropriate, the lattice does not have a big enough opening, and/or the unit is installed in the inner part. Install the unit as near the lattice door as possible.
- Q10** Strange sound is occasionally heard from the bottom air outlet.
- A10** When the damper is switched, scrambling of air will occur between the top and bottom outlets due to the set fan speed during switching and filter clogged state, which, may generate some sound.

# TROUBLE SHOOTING

## PRECAUTIONS FOR CHECKING



### CAUTION

- Remember that the 0V line is biased to 320 – 360V in reference to the ground level.
- Also note that it takes about 10 minutes until the voltage fall after the power switch is turned off.

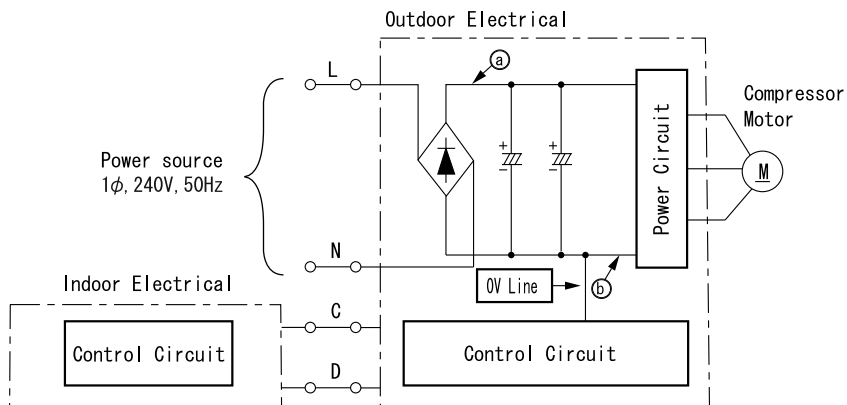

Across a – b (0V line) ----- approx 320 – 360V  
 Across a – ground ----- approx 155 – 170V  
 Across b (0V line) – ground ----- approx 155 – 170V



### CAUTION

When using an oscilloscope, never ground it. Don't forget that high voltages as noted above may apply to the oscilloscope.

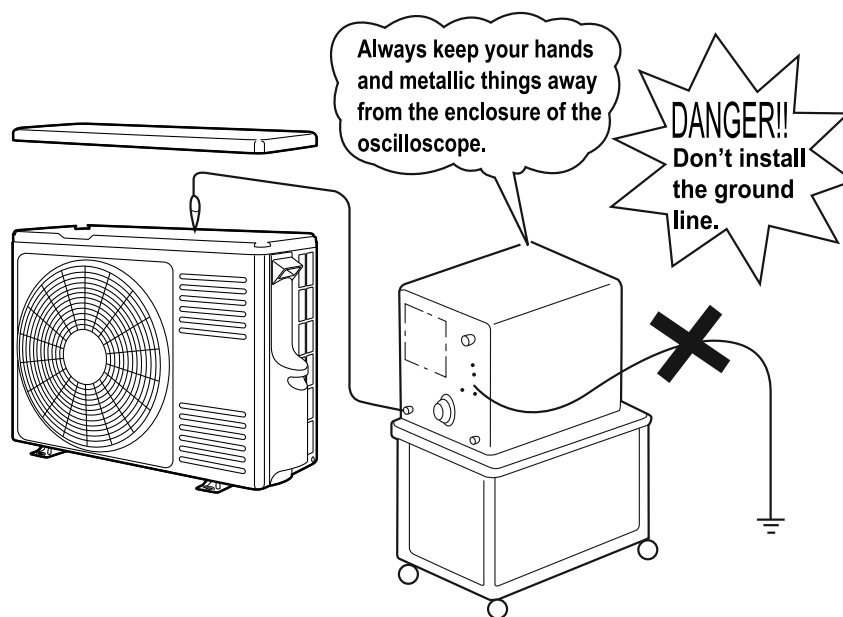

# DISCHARGE PROCEDURE AND METHOD TO STOP ENERGIZE THE POWER CIRCUIT

## ⚠ WARNING ⚡

### Caution

- Voltage of about 300–330V is charged between both ends of smoothing capacitors.
- During continuity check for each part of circuit in outdoor electrical parts, be sure to discharge smoothing capacitor to prevent secondary trouble.

1. Turn OFF power supply to the outdoor unit.
2. After power is turned OFF, wait for 15 minutes or more. Then remove electrical parts cover and apply soldering iron of 30 to 75W for 15 seconds or more to DC voltage ⊕ and DC voltage ⊖ terminals in order to discharge voltage in smoothing capacitors.

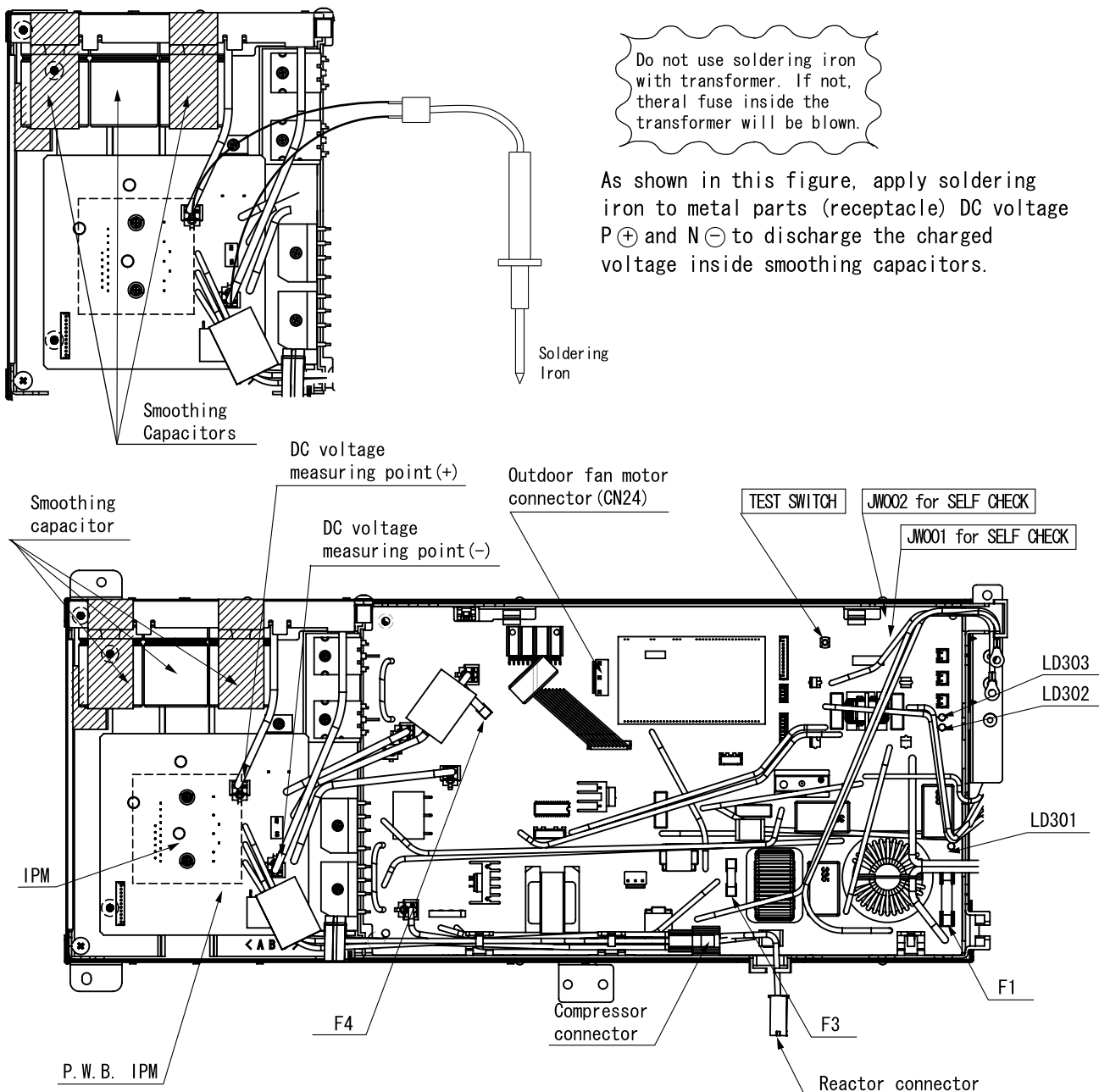

## [Other cautions]

### (1) Disconnection of tab terminal receptacle

All receptacle used to connect with tab terminal are built with lock mechanism. Please take note that by using a force to pull out the receptacle without releasing the lock, can cause a damage. Furthermore, during connecting the receptacle back make sure to securely insert until end.

\* Receptacle type and procedure to releasing the lock

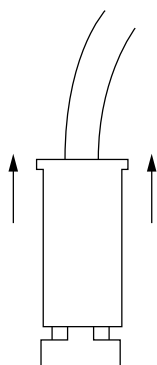

Vertical type (with plastic casing)

Pull out by holding the plastic casing.

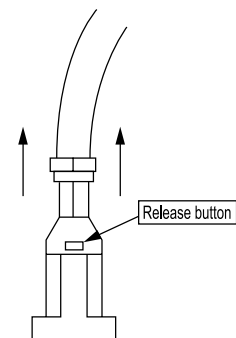

Vertical type (without casing)

Pull out while pushing the release button.

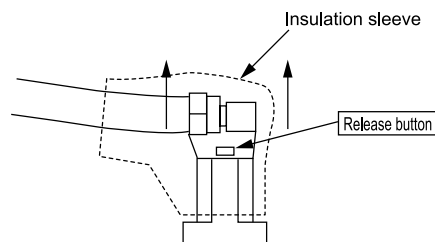

Horizontal type (with insulation sleeve)

Pull out from top of insulation sleeve while pushing the release button.

### (2) Disconnecting on board connector

On board connector with lock mechanism are widely used. Please take note that by using a force to pull out without releasing the lock mechanism, can cause a damage.

Furthermore, during inserting back the connector make sure it surely done.

Release lock with finger before disconnecting.

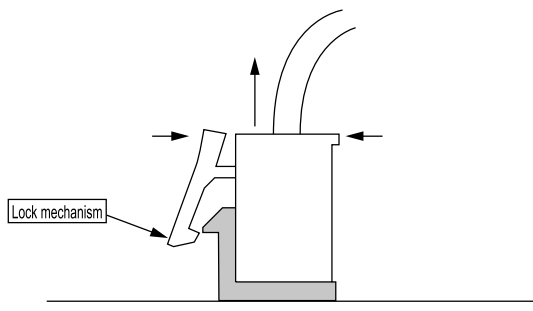

### (3) Connector disconnection during discharge is prohibited

Disconnecting connector during discharge is extremely prohibited. Component on board and fan motor will damage. Proceed trouble shooting process after confirming smoothing capacitor of indoor & outdoor pwb has been discharge.



# CHECKING THE INDOOR TIMER LAMP IF BLINKING 1 TIME

<Caution> Please turn OFF power supply before proceed with below checking flow.

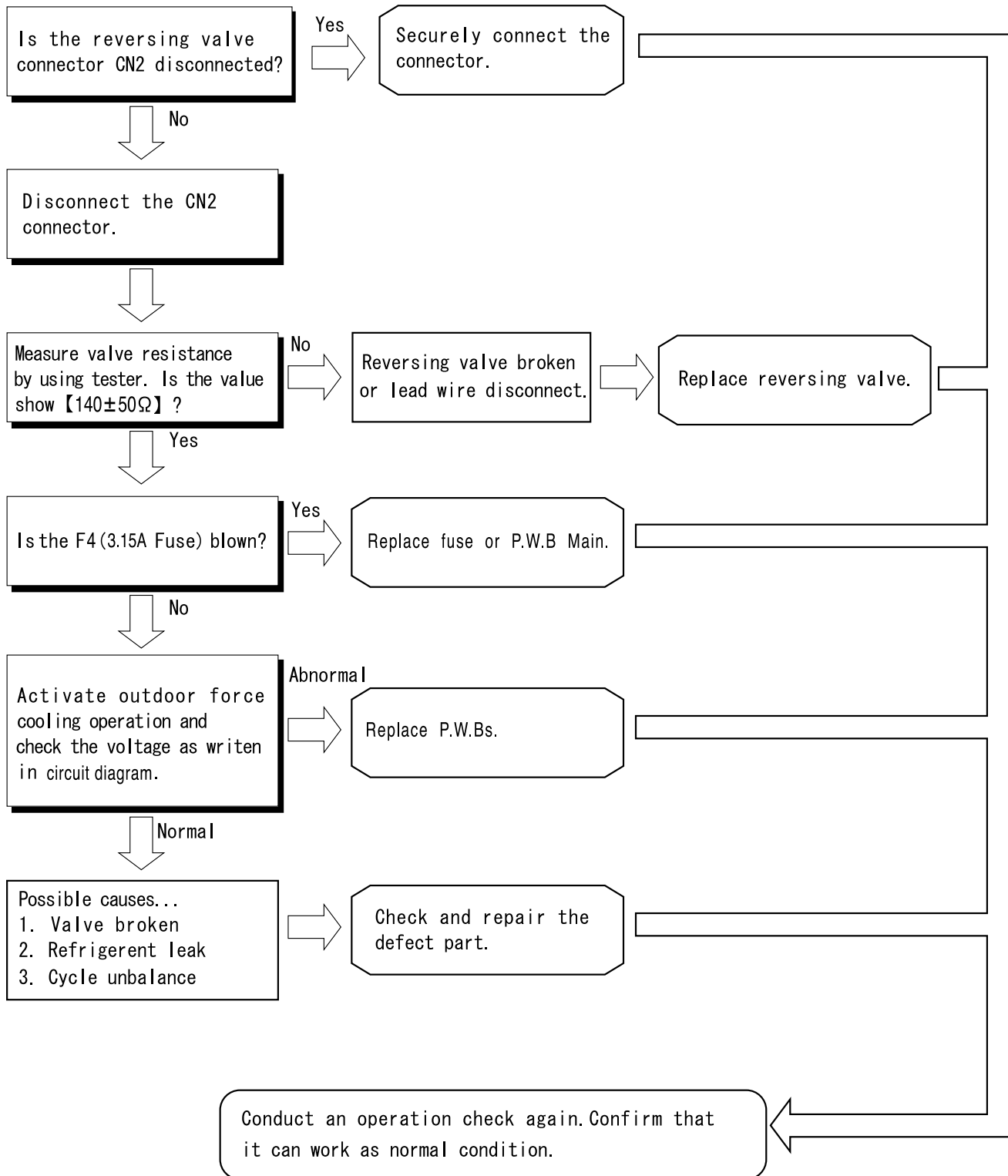

# CHECKING THE INDOOR/OUTDOOR UNIT ELECTRICAL PARTS AND REFRIGERATING CYCLE

MODEL RAK-60PPA

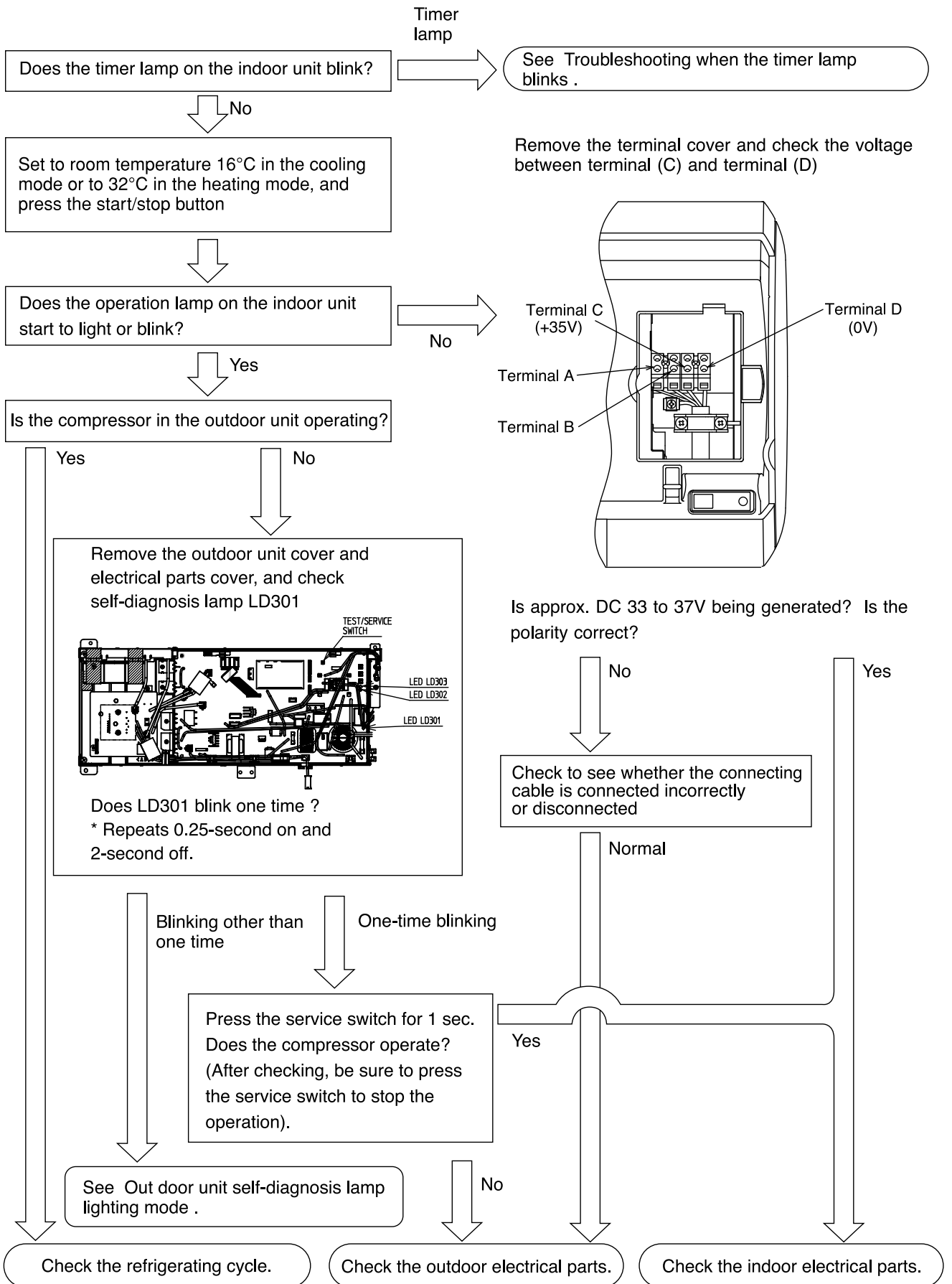





## TROUBLESHOOTING WHEN TIMER LAMP BLINKS.

MODEL RAK-60PPA

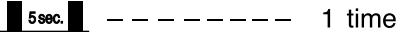
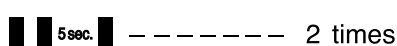
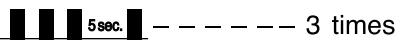
Perform troubleshooting according to the number of times the indoor timer lamp and outdoor LD301 blink.

### SELF-DIAGNOSIS LIGHTING MODE

No.	Blinking of Timer lamp	Reason for indication	Possible cause
1	 1 time	<u>Refrigerant cycle defective</u> When the indoor heat exchanger temperature is too low in the heating mode or it is too high in the cooling mode.	(1) Reversing valve defective (2) Heat exchanger thermistor disconnected (only in the heating mode) (Note) The malfunction mode is entered the 3rd time this abnormal indication appears (read every 3 minutes).
2	 2 times	<u>Outdoor unit forced operation</u> When the outdoor unit is in forced operation or balancing operation after forced operation	Electrical parts in the outdoor unit
3	 3 times	<u>Indoor/outdoor interface defective</u> When the interface signal from the outdoor unit is interrupted.	(1) Indoor interface circuit (2) Outdoor interface circuit
4	 4 times	Outdoor electrical assembly defective.	Please check at the outdoor electrical led lamp blinking (LD301) and refer to self diagnosis lighting mode for outdoor unit.
5	 9 times	<u>Room thermistor or heat exchanger thermistor is faulty</u> When room thermistor or heat exchanger thermistor is opened circuit or short circuit.	(1) Room thermistor (2) Heat exchanger thermistor
6	 10 times	<u>Over-current detection at the DC fan motor</u> when over-current is detected at the DC fan motor of the indoor unit.	(1) Indoor fan locked (2) Indoor fan motor (3) Indoor control P.W.B.
7	 13 times	<u>IC401 data reading error</u> When data read from IC401 or IC402 is incorrect.	IC401 abnormal

(  -- Lights for 0.5 sec. at interval of 0.5 sec..)

### <Cautions>



- (1) If the interface circuit is faulty when power is supplied, the self-diagnosis display will not be displayed.
- (2) If the indoor unit does not operate at all, check to see if the connecting cable is connected or disconnected.
- (3) To check operation again when the timer lamp is blinking, you can use the remote control for operation (except for mode mark ※1).

## SELF-DIAGNOSIS MEMORY FUNCTION





Failure modes are stored in the nonvolatile memory of indoor unit and shall be redisplayed by remote controller.



This function is useful in checking the failure modes either during switching OFF the power or restarting the device without checking the number of indication lamp blinking. Remote controller can redisplay up to last 5 failure modes from the memory. However, failure modes which are rarely to occur are also stored in the memory which caused the numbers of failure more than 5. Thus, for some failure modes which are unable to retrieve because of remote controller limit to redisplay only 5 failure modes, it can be found by clearing up the memory first then recheck the memory content again during the visit at the customer place.

### < How to redisplay failure diagnosis >



1. Turn the circuit breaker OFF.
2. Set the remote controller to OFF condition, indicated by **OFF** on the display.
3. By pressing  (MODE) button on the remote controller, set to Cooling operation indicated by  (COOL).
4. Turn the circuit breaker ON.
5. Set the room temperature setting on the remote controller to 32°C by pressing the (TEMP  $\downarrow$  or  $\uparrow$ ) button.
6. Set the fan speed with the  (FAN SPEED) button according to the desired failure information. (Refer to the corresponding table below)

Fan speed settings for failure data

Fan Speed	Data
AUTO 	Newest
HI 	Second newest
MED 	Third newest
LOW 	Fourth newest
SILENT 	Oldest

7. While directing the remote controller towards the receiver of the indoor unit, press (TEMP  $\uparrow$ ) button and  (START/STOP) button simultaneously. (The remote controller perform signal transmission with the device.)
8. The device beeps [Pi-] to indicate that it has just received the signal to redisplay the failure mode.
9. Direct the remote controller towards the receiver of indoor unit (within 2 meters in front of indoor unit) and press the  (INFO) button. Wait for 2 seconds for signal transmission. An error code will be displayed on the remote controller display.

### < How to clear the troubleshooting data >

1. Redisplay the troubleshooting status. (See the above procedure.)
2. Turn the circuit breaker OFF.
3. By pressing  (MODE) button on the remote controller, set to Heating operation indicated by  (HEAT).
4. Turn the circuit breaker ON.
5. Set the room temperature setting on the remote controller to 16°C by pressing the (TEMP  $\downarrow$  or  $\uparrow$ ) button.
6. While directing the remote controller towards the receiver of the indoor unit, press (TEMP  $\downarrow$ ) button and  (START/STOP) button simultaneously. (The remote controller perform signal transmission with the device.)
7. The product beeps for a second [Pi-] to indicated that it has just received the signal. The data has now been cleared.

### < How to display error code in case of failure just occurs >

If timer lamp  of the indoor unit blinking and operation stops, please perform below procedures.

1. Direct the remote controller towards the receiver of indoor unit (within 2m in front of the indoor unit) and press  (INFO) button.
2. Wait for 2 seconds for signal transmission.
3. Indication of error code will be shown on the remote controller display for 10 seconds.

For example :

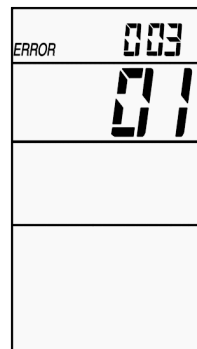
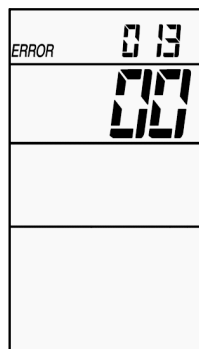

	TIMER LAMP BLINKING	LD301 BLINKING	CODE	MEANING	DETAILS	MAIN CHECK POINT
INDOOR	-	-	000 00	Normal		
	1 time	-	001 00	Refrigerant cycle fault	When the indoor heat exchanger temperature is too low in the heating mode or it is too high in the cooling mode.	1. Reversing valve defective 2. Heat exchanger thermistor disconnected. (only in heating mode)
	2 times	-	-	Outdoor unit is under forced operation.	It is not failure. Outdoor unit is in forced operation or balancing operation after forced operation.	1. Electrical parts in the outdoor unit.
	3 times	-	003 00	Communication error between indoor and outdoor units.	Interface signal from the outdoor unit is interrupted.	1. Indoor interface circuit 2. Outdoor interface circuit
	9 times	-	009 00	Indoor thermistor	Room thermistor or heat exchanger thermistor is opened circuit or short circuit.	1. Room thermistor 2. Heat exchanger thermistor
	10 times	-	010 00	Abnormal rotating numbers of DC fan motor	Overcurrent is detected at the DC fan motor of the indoor unit.	1. Indoor interface circuit 2. Outdoor interface circuit 3. Indoor control P.W.B
	13 times	-	013 00	IC401 data reading error	When data read from IC401 or IC402 is incorrect.	1. IC401 or IC402 abnormal
OUTDOOR	4 times	2 times	002 01	Peak current cut	Over current is detected.	1. Compressor 2. P.W.B.s
	4 times	3 times	003 01	Compressor abnormal low speed rotation	Position detection signal is not input during operation.	1. P.W.B.s 2. Compressor
	4 times	4 times	004 01	Compressor switching failure	Fail to switch from initial low frequency sync to position detection sync.	1. P.W.B.s 2. Compressor
	4 times	5 times	005 01	Overload lower limit cut	Overload condition still persisting even when rotation speed is below the lower rpm limit.	1. Outdoor unit is exposed to direct sunlight or its air flow blocked. 2. Fan motor 3. Fan motor circuit 4. The voltage is extremely low.
	-	6 times	006 01	OH thermistor temperature rise	OH thermistor is operating.	1. Leak of refrigerant 2. Compressor 3. OH thermistor circuit 4. Fan motor 5. Fan motor circuit
	4 times	7 times	007 01	Abnormal outdoor thermistor	Thermistor is opened or shorted.	1. Thermistor 2. Connection of thermistor is faulty 3. Thermistor circuit
	4 times	8 times	008 01	Acceleration defective		
	-	9 times	009 01	Communication error	When indoor unit is not connected, it blinks similarly, not malfunction.	1. Cable is wrong connected 2. Cable is open 3. Interface circuit between indoor and outdoor unit
	-	10 times	010 01	Abnormal power source	Power supply voltage is incorrect.	1. Power supply voltage 2. Receptacle of wire for P.W.BIPM is not properly inserted
	-	11 times	011 01	Fan stop for strong wind	Fan motor load is too heavy or rotation disturbed by wind blow.	1. Fan motor 2. Outdoor condition (wind)
	4 times	12 times	012 01	Fan motor fault	Outdoor fan rpm is not rotate as intended rpm.	1. Fan motor 2. Fan motor circuit
	4 times	13 times	013 01	EEPROM reading error	Microcomputer cannot read the data in EEPROM.	1. P.W.B main
	4 times	14 times	014 01	Active converter defective	Over voltage is detected, compressor abnormal load.	1. P.W.B.s 2. Compressor
	4 times	15 times	015 01	Abnormal PWB circuit	Active circuit abnormal.	1. P.W.B.s
-	16 times	016 01	Software peak current cut			

< Cautions >

This function is effective only once immediately after the power is turned on. It will not work if you have performed another remote control operation beforehand. Note also that it may not function in response to a procedure other than the above. (If it does not work, turn off the power, turn it back on and repeat the procedure.)

If the memory stores nothing, performing a redisplay operation will not blink the lamp.

For a normal operation, turn off the power and turn it back on. After the above operation, the product will not receive a remote control signal normally.

After clearing the troubleshooting data, turn off the power. (If you do not turn off the power, the product will become unresponsive to remote control signals.)

# CHECKING INDOOR UNIT ELECTRICAL PARTS

MODEL RAC-60WPA

## 1. Power does not come on (no operation)

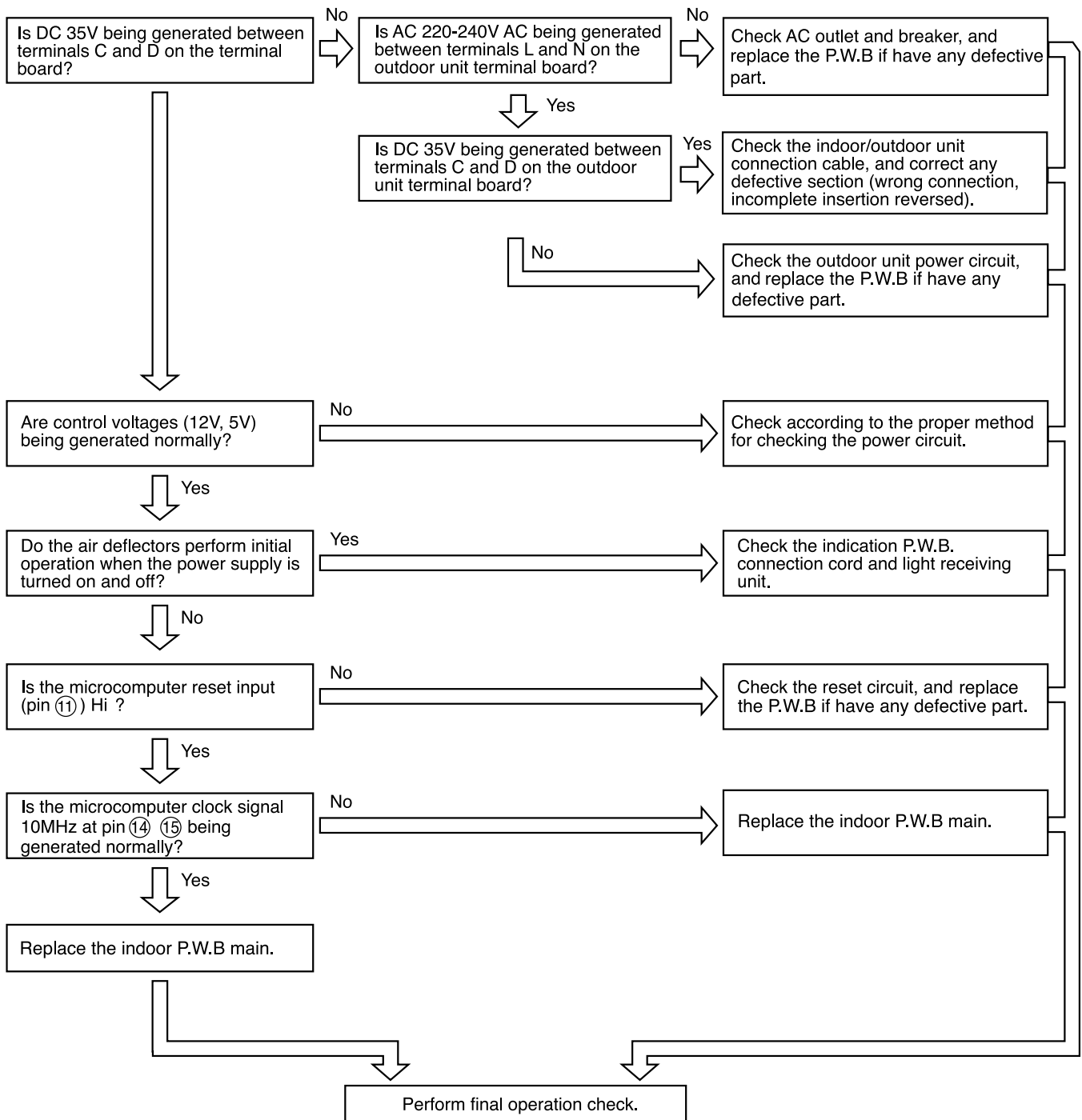

**2. Outdoor unit does not operate (but receives remote infrared signal)**

Set to room temperature 16°C in the cooling mode or to 32°C in the heating mode, and press the start/stop button.



Remove the outdoor unit cover and electrical parts cover, and check self-diagnosis lamp LD301.

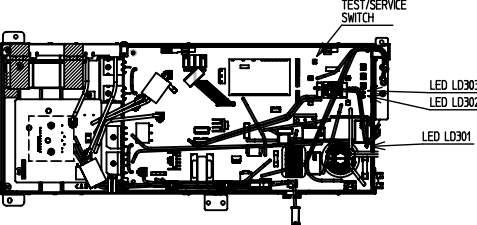

Does LD301 blink one time?  
\*Repeats 0.25-second on and 2-second off.

Yes →

Check the room temperature thermistor; if it is defective, replace it.  
<Normal values>  
10°C → approx. 20kΩ  
25°C → approx. 10kΩ  
30°C → approx. 8kΩ

Check the heat exchanger thermistor; if it is defective, replace it.  
<Normal values>  
10°C → approx. 20kΩ  
25°C → approx. 10kΩ  
30°C → approx. 8kΩ

No ↓

Does outdoor electrical part LD301 blink nine times?

Yes →

Is the indoor/outdoor unit communication signal superimposed on 35V DC of connection wires C and D?

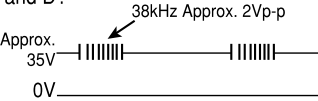

No →

Check outdoor electrical parts, and replace the outdoor P.W.B main.

Yes ↓

Is the indoor transmitting signal being generated at Q801's collector?

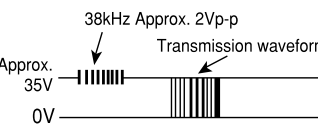

No →

Check the indoor interface transmitting circuit. Replace the indoor P.W.B main.

Yes →

Check outdoor electrical parts, and replace the outdoor P.W.B main.

No ↓

Does LD303 switch off several second after it lights?

Yes →

Check outdoor electrical parts, and replace the outdoor P.W.B main.



Perform final operation check.

### 3. Only indoor fan does not operate (other is normal)

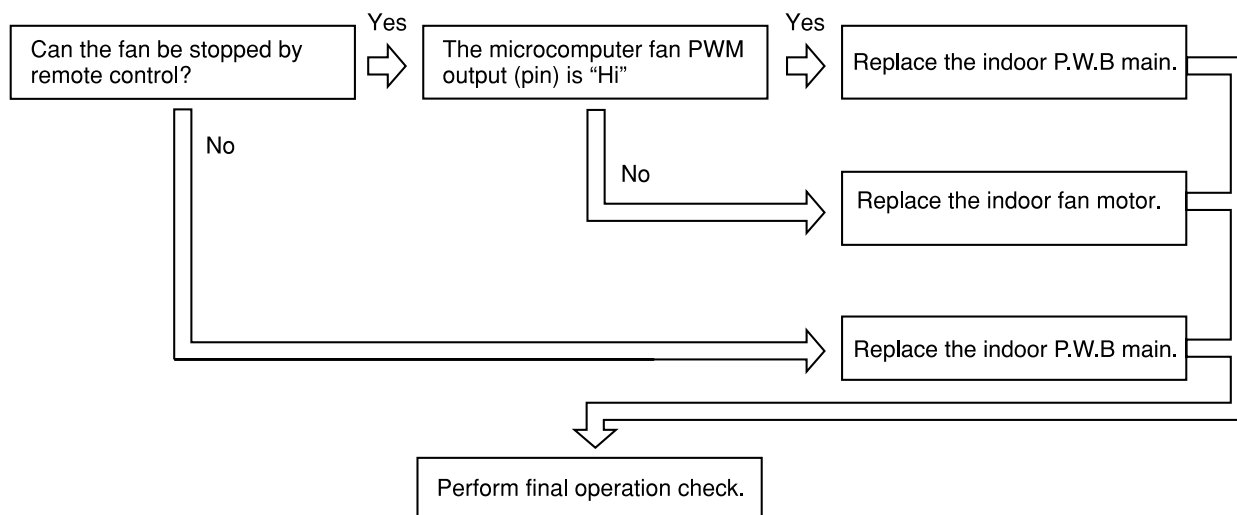

### 4. Air deflector does not move (others are normal)

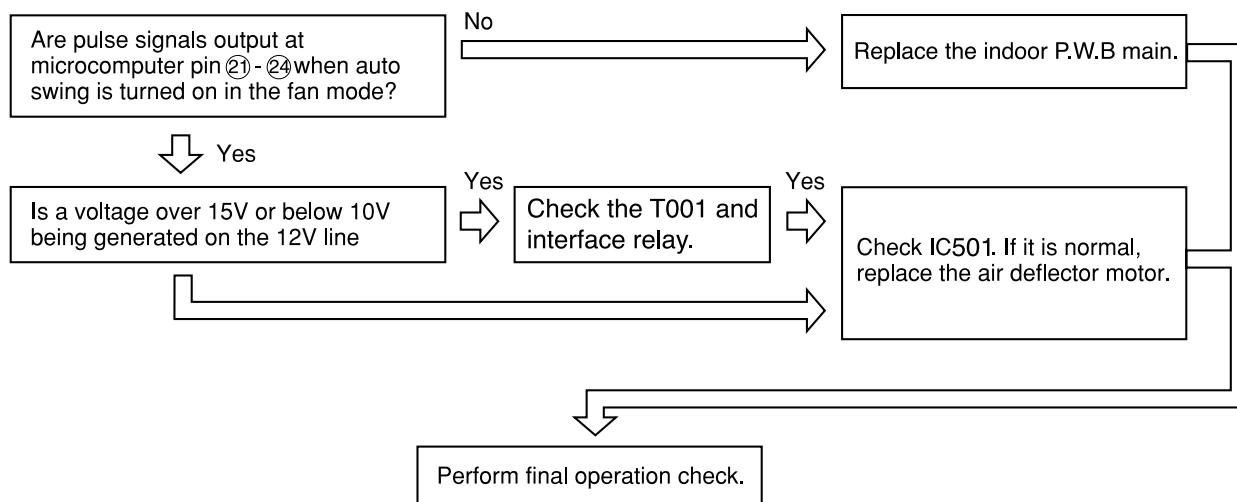

### 5. All systems stop from several seconds to several minutes after operation is started (all indicators are also off)

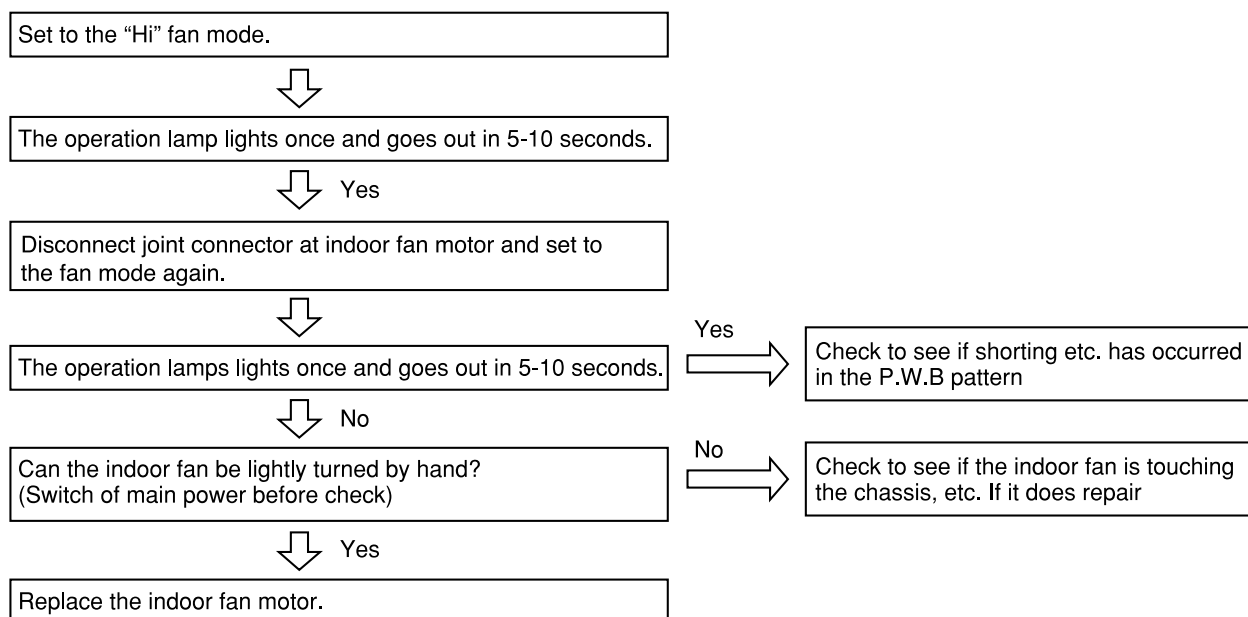



## 6. Check the main P.W.B (power circuit)

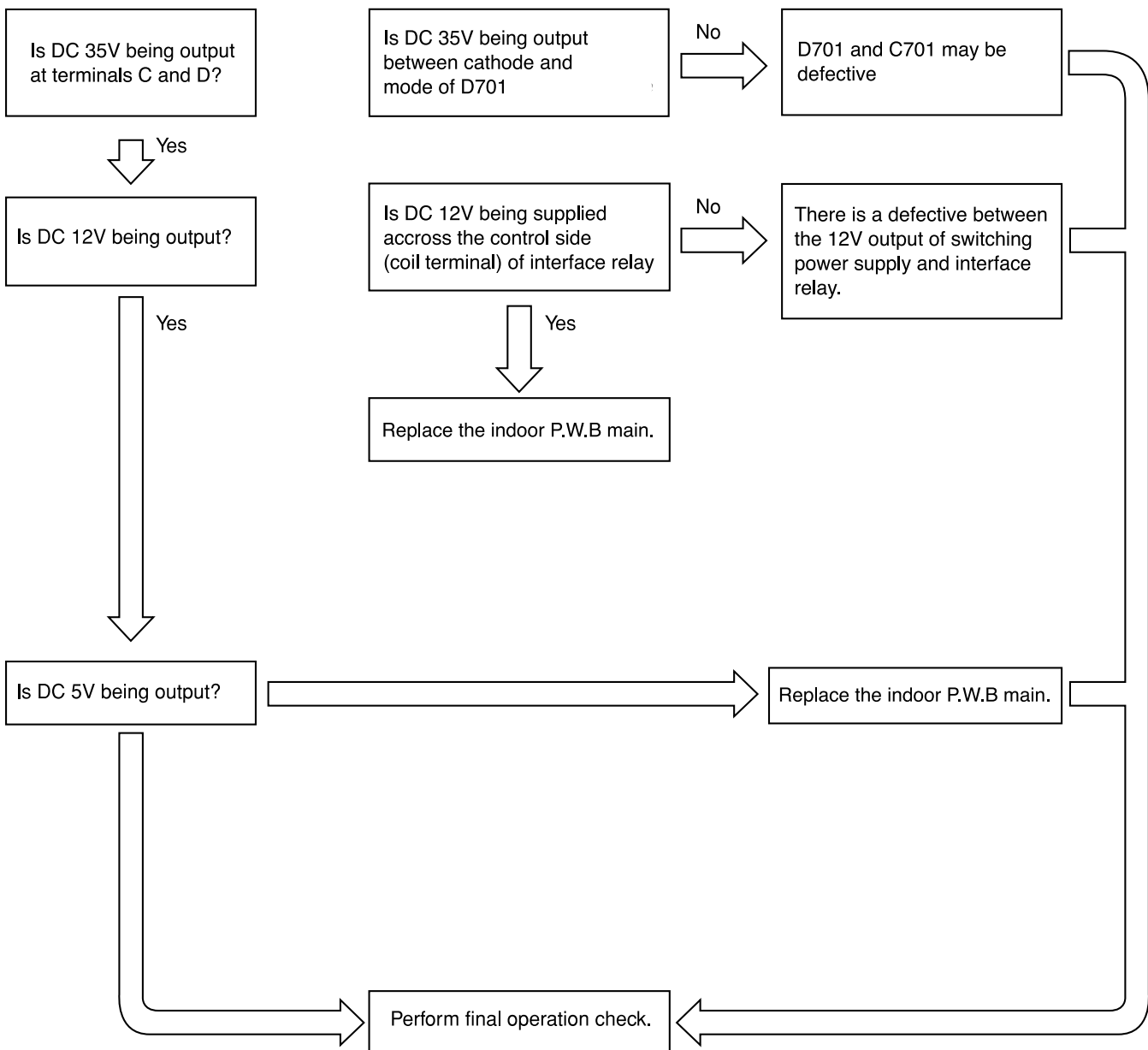

# CHECKING THE OUTDOOR UNIT ELECTRICAL PART

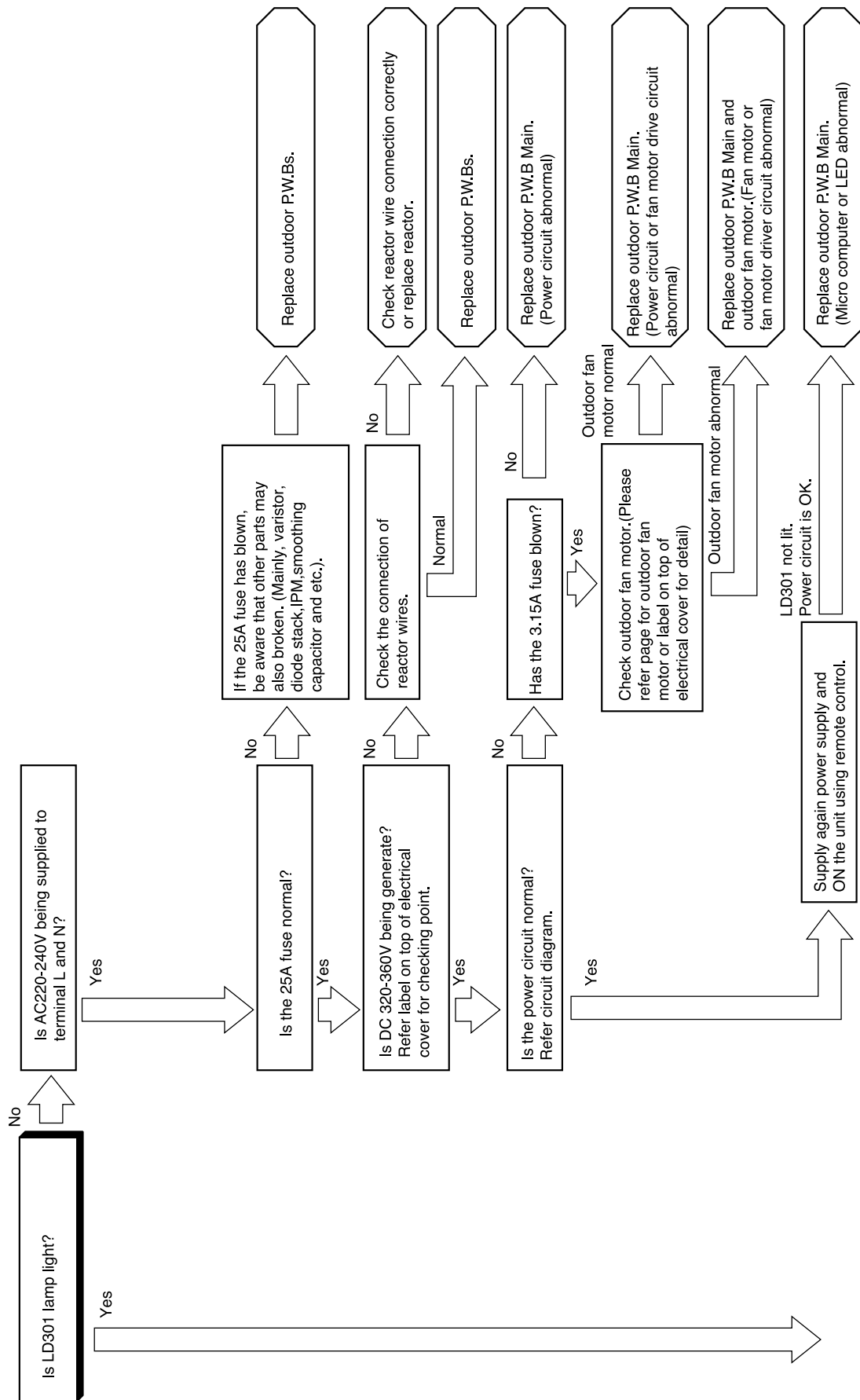

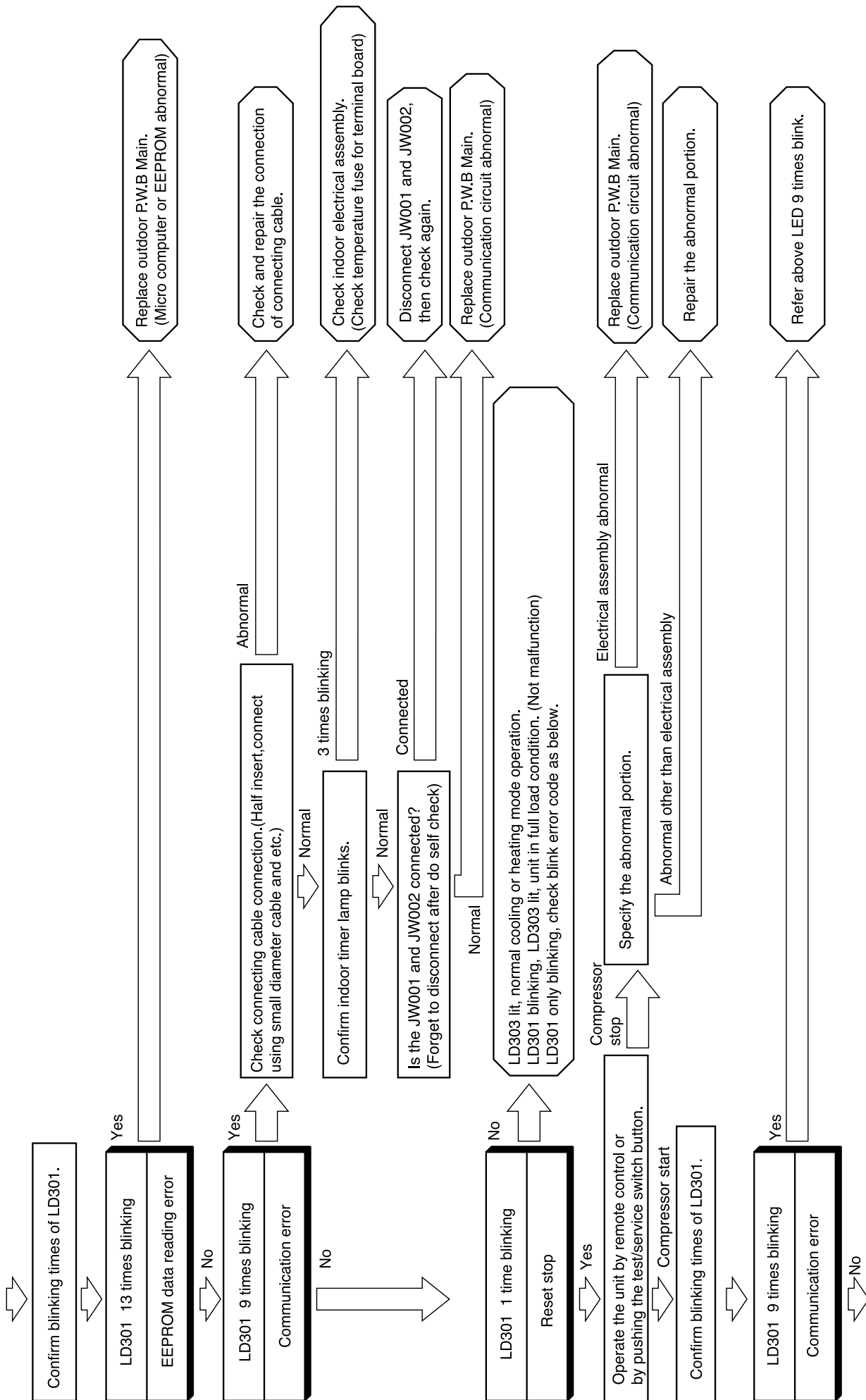

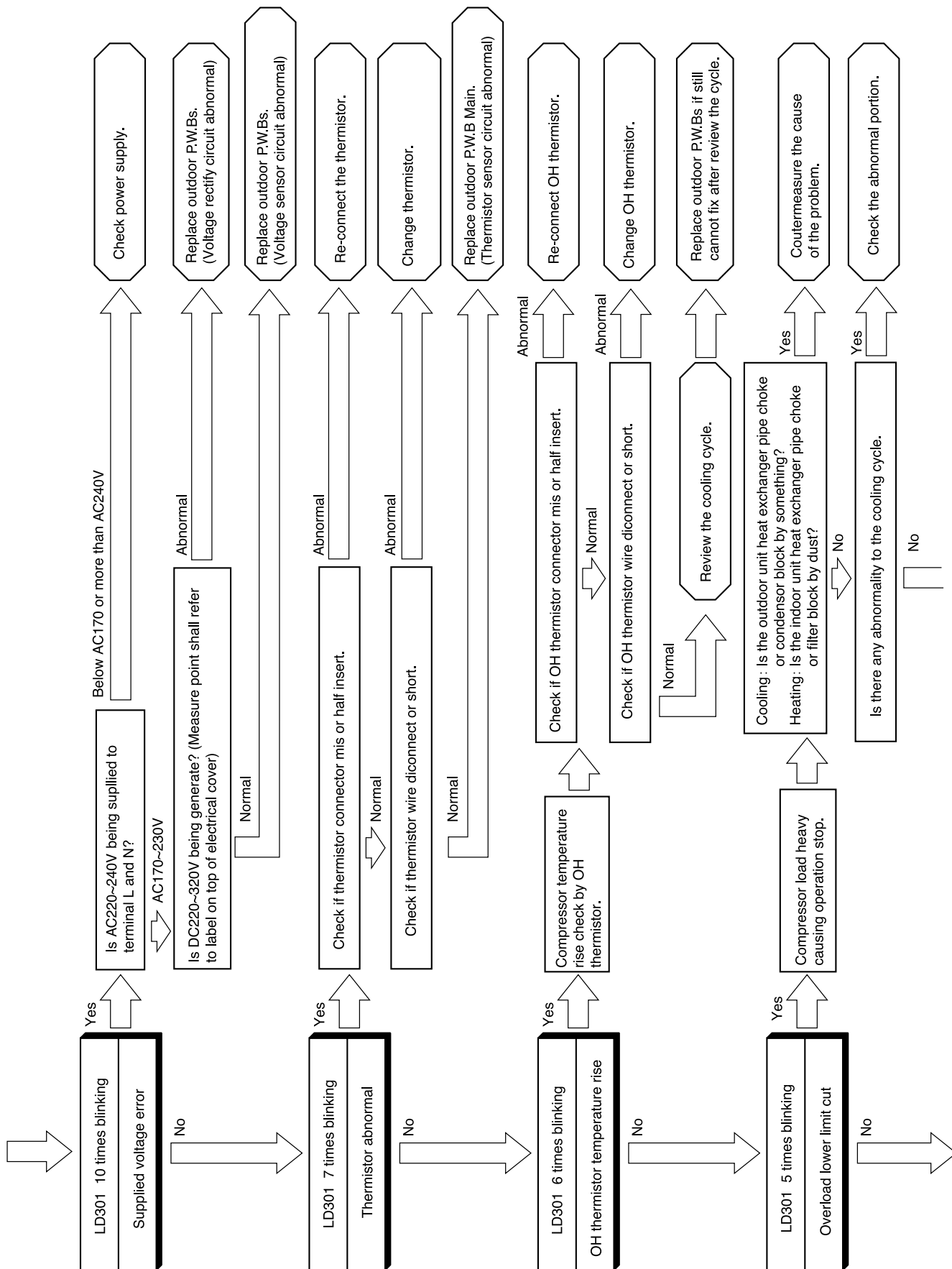

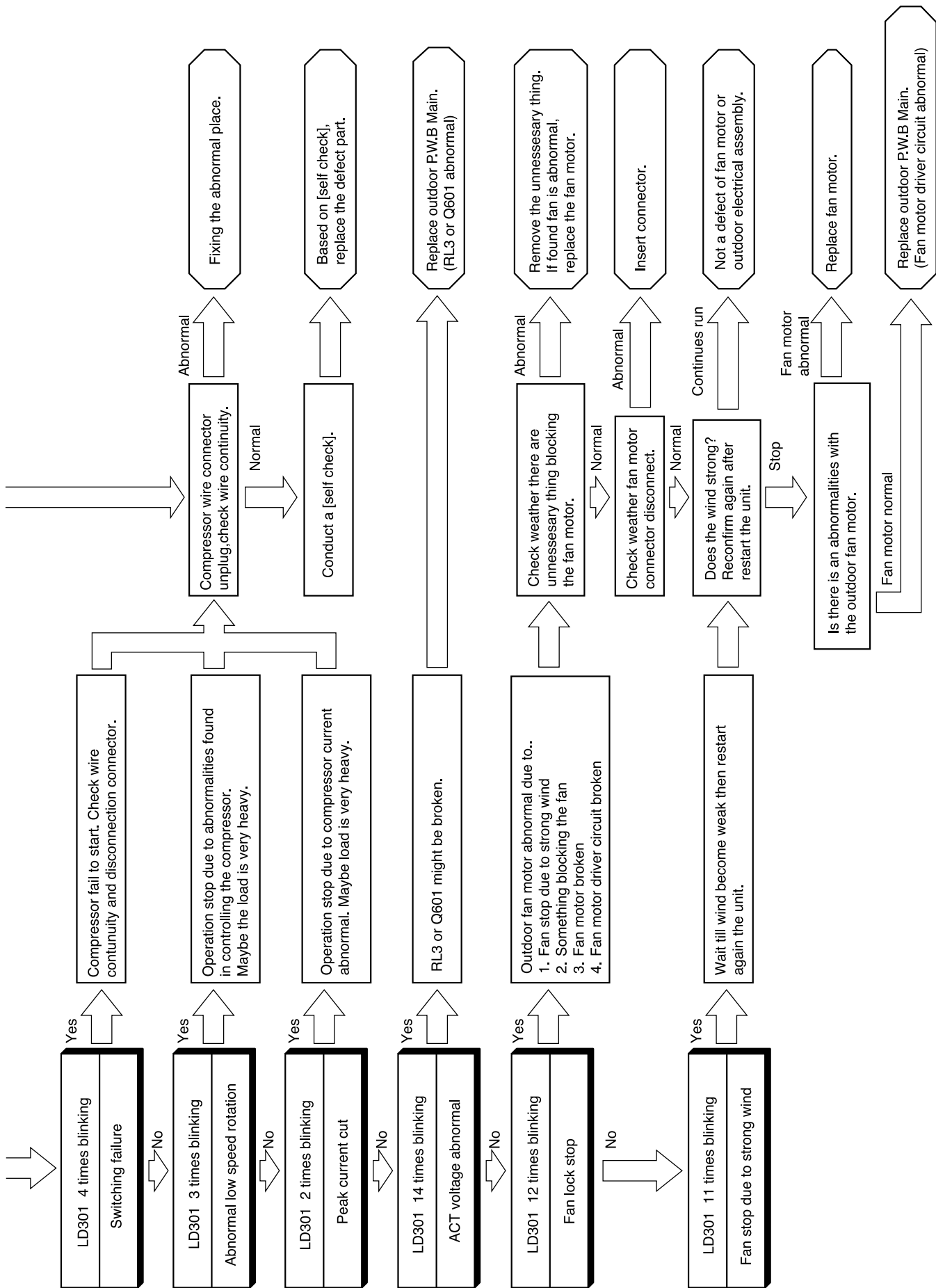







## HOW TO CHANGE THE SHIFT VALUE SETTING TEMPERATURE

The shift value setting temperature for Cooling and Heating mode operation can be change using remote controller. (This procedure shall be implemented strictly by service personnel only.)

(For initial shift value temperature setting for Cooling mode (SHIFTC) and Heating operation mode (SHIFTW) : Please refer to page 63)





### PROCEDURES

1. While pressing and holding  (START/STOP) button and  (ON) button, press  [RESET] button on the same. Release  [RESET] button only and make sure that all marks on the remote controller display are indicated, then release the  (START/STOP) button and  [ON] button. Remote controller now enters "Shift Value Change Mode".

2. Press the  (MODE) selector button so that the display indicates  (FAN) mode.

3. Press the  (START/STOP) button and FAN operation will be started.

4. Set the FAN SPEED with the  (FAN SPEED) button according to the following FAN speed setting in order to choose the desired operation mode that is required for shift value setting temperature modification.

- To change the shift value for COOLING mode operation, select either  (HIGH) or  (MED) FAN SPEED.
- To change the shift value for HEATING mode operation, select either  (LOW) or  (SILENT) FAN SPEED.

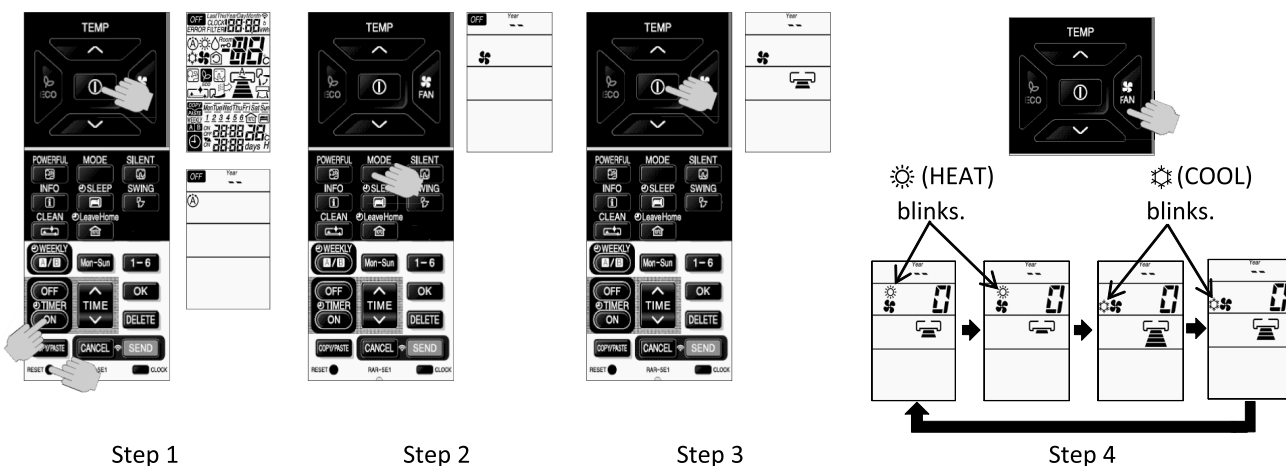

5. Press the (TEMP  $\downarrow$  or  $\uparrow$ ) button to change the shift value. (The shift value changed with device beep sound.)

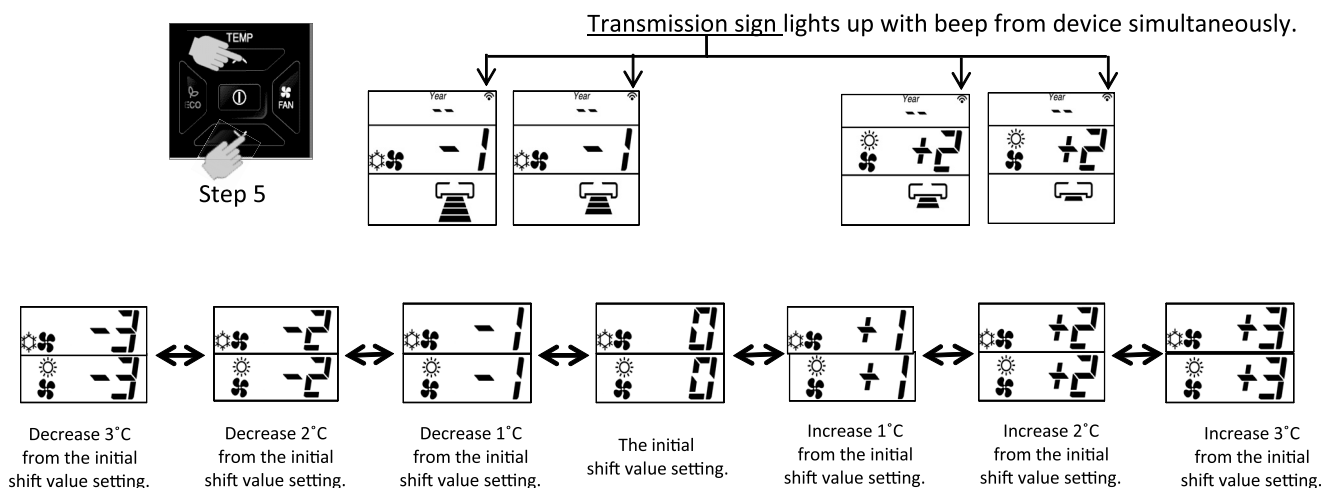

## SETTING THE PREVENTION OF MUTUAL INTERFERENCE FOR REMOTE CONTROLLER

( Applicable for Remote controller model : RAR-5E1, RAR-5E2, RAR-5E3, RAR-5E4 and RAR-5E5 )

Case : 2 sets of indoor units installed near to each other.

If both indoor units can receive the same remote controller signal, please set the remote controller as below. ( This setting will change the signal address of each remote controller.)

Initial remote controller signal address setting is **A**.

This procedure change the remote controller signal address from **A** to **B**.

1. The circuit breaker for the other unit shall be OFF.



2. Slide the remote controller cover to take it off.

3. While directing the remote controller towards the receiver of the indoor unit, press **1-6** button, **ON TIMER** button and **RESET** button simultaneously. (The remote controller perform signal transmission with the device.)

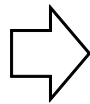
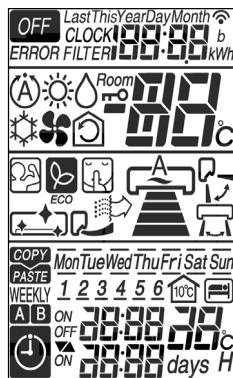
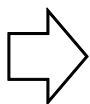

Signal transmission : From A to B

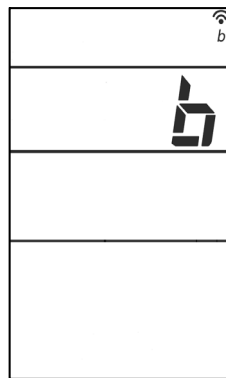

4. The indoor unit beeps [Pip] to indicate that it has just received the signal from remote controller.



5. Please check the usability of each set of indoor unit using its own remote controller.

Note : If indoor unit still not receive the correct signal from the correct remote controller, setting shall be made again.

By setting again for the 2nd time, the signal address will change from **B** to **A**. Then, if repeat again for the 3rd time, the remote controller signal address will change from **A** to **B**.

Signal transmission : From B to A

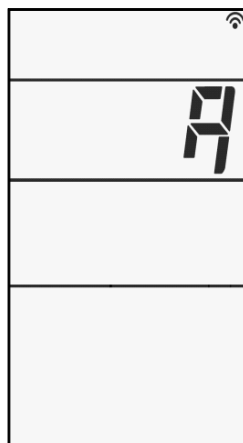

# OPERATION MODE LOCK SETTING

If Dip switch position is set at "Heating mode only" or "Cooling mode only" as mentioned on page 86, it is required to set the remote controller into operation mode lock setting. Without setting the remote controller, it will caused unmatched signal transmission between indoor unit and remote controller.

## PROCEDURE

### 1. Heating operation mode lock setting

- (a) While pressing and holding (ECO) button and (POWERFUL) button, press (RESET) button on the same time. Release (RESET) button only and make sure that all marks on the remote controller display are indicated, then release the (ECO) button and (POWERFUL) button. Remote controller now enters "Heating operation mode lock".
- (b) To cancel the "Heating operation mode lock", repeat the above procedure (1(a)).

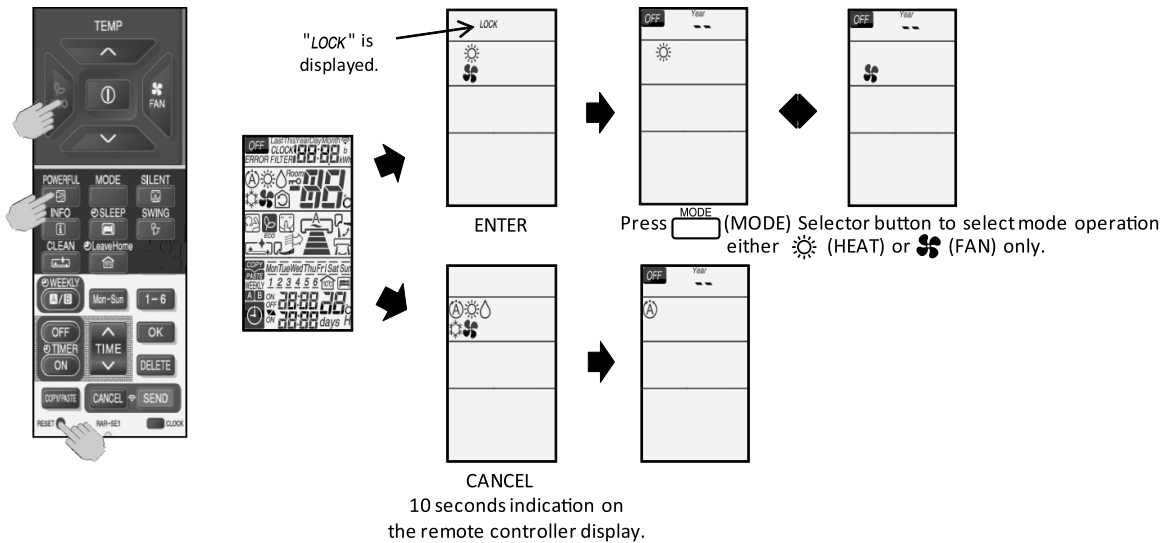

### 2. Cooling operation mode lock setting

- (a) While pressing and holding (ECO) button and (SILENT) button, press (RESET) button on the same time. Release (RESET) button only and make sure that all marks on the remote controller display are indicated, then release the (ECO) button and (SILENT) button. Remote controller now enters "Cooling operation mode lock".
- (b) To cancel the "Cooling operation mode lock", repeat the above procedure (2(a)).

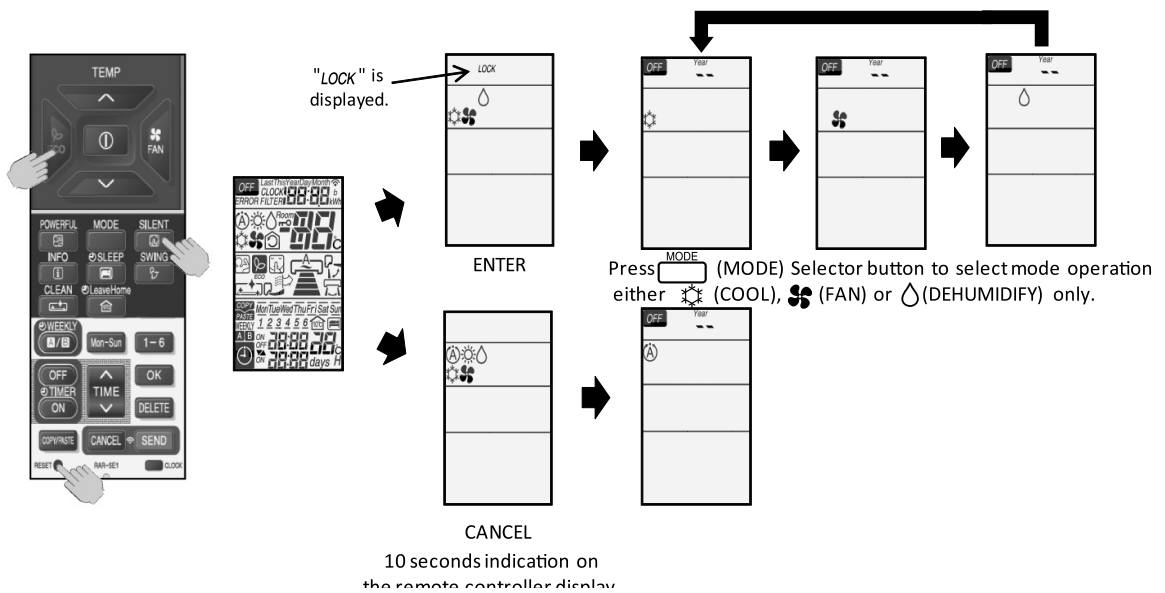













## DISPLAY OPERATION MODE SETTING

For operating indoor unit independently (without outdoor unit connection), remote controller has to be set according to below procedures before send the signal to the indoor unit. New communication format between indoor and outdoor is required to communicate with outdoor unit.

### PROCEDURE

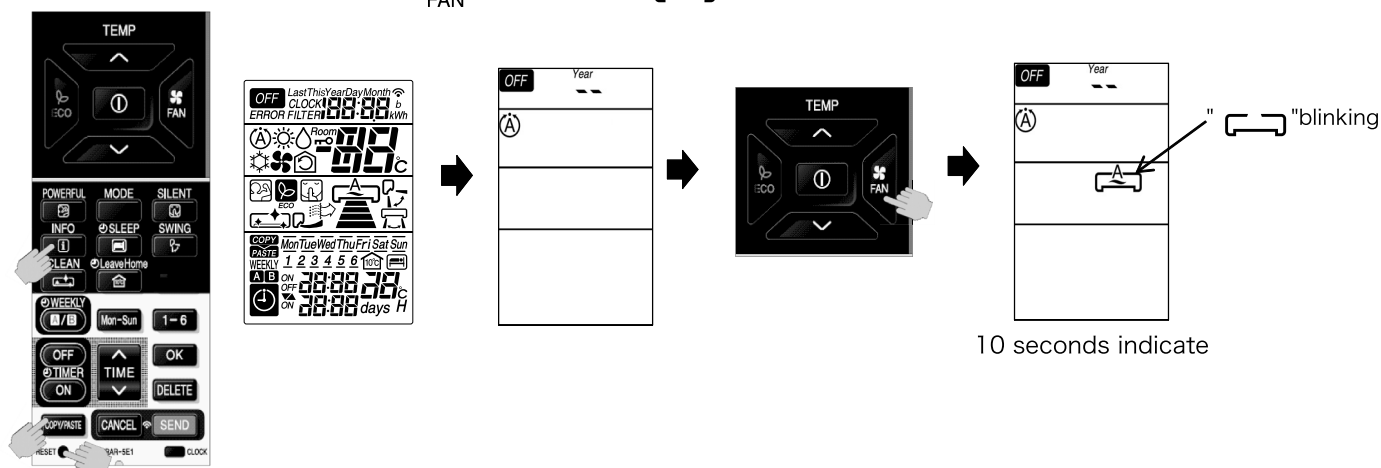
- While pressing and holding  (INFO) button and  (COPY/PASTE) button, press  (RESET) button on the same time. Release  (RESET) button only and make sure that all marks on the LCD display are indicated, then release the  (INFO) button and  (COPY/PASTE) button. Remote controller now enters "DISPLAY OPERATION MODE" for the indoor unit to run independently. Please ensure that when pressing  (FAN) button, "" will blinking.



- Press the  (MODE) selector button to choose the desired operation mode.
- Press  (START/STOP) button.  
Then, the indoor unit will starts to operate independently accoring the selected operation mode.

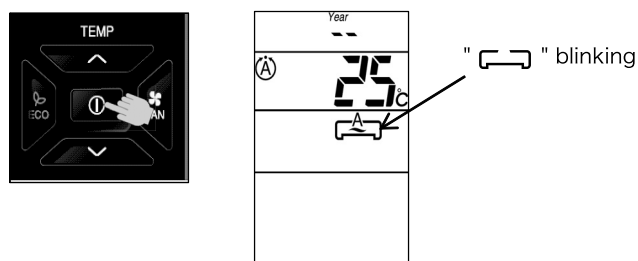

### NOTE :

- (1) During "DISPLAY OPERATION MODE", "" blinks on LCD of remote controller.
- (2) When operation stops, "DISPLAY OPERATION MODE" is canceled.

# SELF CHECK

When self-diagnosis lamp blinks 2,3,4 and 5 times happen, to determine whether compressor faulty or electrical unit faulty, please conduct a SELF CHECK as below.

1. Switch OFF main power supply.
  2. Short circuit between JW001 and JW002.
  3. Switch ON main power supply – LD301 will blink 1 time.
  4. (Within 3 minutes) Press Test/Service Switch for 1 second or more.
  5. Self-diagnosis result will be shown – LD303 will ON (LIT) and LD301 will be blinking. Then refer to diagnosis table 2.
  6. Switch OFF main power supply. Then release back JW001 and JW002 to original condition (no short circuit condition).
- \* If step No. 6 is not carried out, the system will not operate properly until 3 minutes has lapsed after restore the power supply.

## \* SELF CHECK diagnosis result

SELF-DIAGNOSIS LIGHTING MODE			■ LIT	☒ BLINKING	□ OFF		
LD301	LD302	LD303				SELF-DIAGNOSIS RESULT	REPAIR METHOD
RED	RED	RED	<input checked="" type="checkbox"/>	<input type="checkbox"/>	<input type="checkbox"/>	ELECTRICAL OK	① CHANGE COMPRESSOR
1 TIME			<input checked="" type="checkbox"/>	<input type="checkbox"/>	<input type="checkbox"/>	PEAK CURRENT CUT OFF	① CHANGE P.W.B.s
2 TIMES			<input checked="" type="checkbox"/>	<input type="checkbox"/>	<input type="checkbox"/>	COMPRESSOR CURRENT ABNORMAL	① IF COMPRESSOR CONNECTOR LOOSE OR NG - CHECK CONNECTOR CONDITION ② IF COMPRESSOR CONNECTOR OK, - CHECK COMPRESSOR, CHANGE P.W.B.s
7 TIMES			<input checked="" type="checkbox"/>	<input type="checkbox"/>	<input type="checkbox"/>	DC VOLTAGE ABNORMAL	① IF AC VOLTAGE INPUT ABNORMAL (OVER STANDARD VOLTAGE ±10%), - FOLLOW STANDARD AC VOLTAGE INPUT ② IF AC VOLTAGE INPUT IS NORMAL (WITHIN ±10%), - CHANGE P.W.B.s
10 TIMES			<input checked="" type="checkbox"/>	<input type="checkbox"/>	<input type="checkbox"/>	EEPROM READING ERROR	① CHANGE P.W.B. MAIN
13 TIMES			<input checked="" type="checkbox"/>	<input type="checkbox"/>	<input type="checkbox"/>		

In case abnormalities found in measurement result, change the defect part.

In case electrical is normal and before it can be use, modify back

**JW001 and JW002 as normal condition (before conduct a self check).**

In case of service person forgot to release JW001 and JW002 to original condition;

### Case 1:

If main power supply continuously ON, outdoor microcomputer will keep showing diagnosis result (LD303 will ON and LD301 will blinks).

### Case 2:

If main power supply OFF at once, then switch ON again:

- a) Outdoor microcomputer will wait the self check command (by pressing test/service switch) (LD301 blinks 1 time) and unit not running.

### Case 3:

If main power supply OFF at once, then switch ON again and on indoor unit by remote control;

- a) Indoor unit LD721 will blinks 4 times, outdoor unit LD301 blinks 1 time, and unit not running.

# HOW TO OPERATE USING OUTDOOR UNIT TEST SWITCH

1. Pull out power cord plug and wait for 1 minute before plug in again.
2. Remove outdoor electrical cover and confirm that LD301 will blink 1 time.
3. Force cooling operation is start when TEST SWITCH is pressed for 1 second or more.

※ (There is a case where operation will only start after 1 minute after pressing the TEST SWITCH due to initializing of the expansion valve)

5. Press again the TEST SWITCH for about 1 minute or more to stop the force cooling operation.

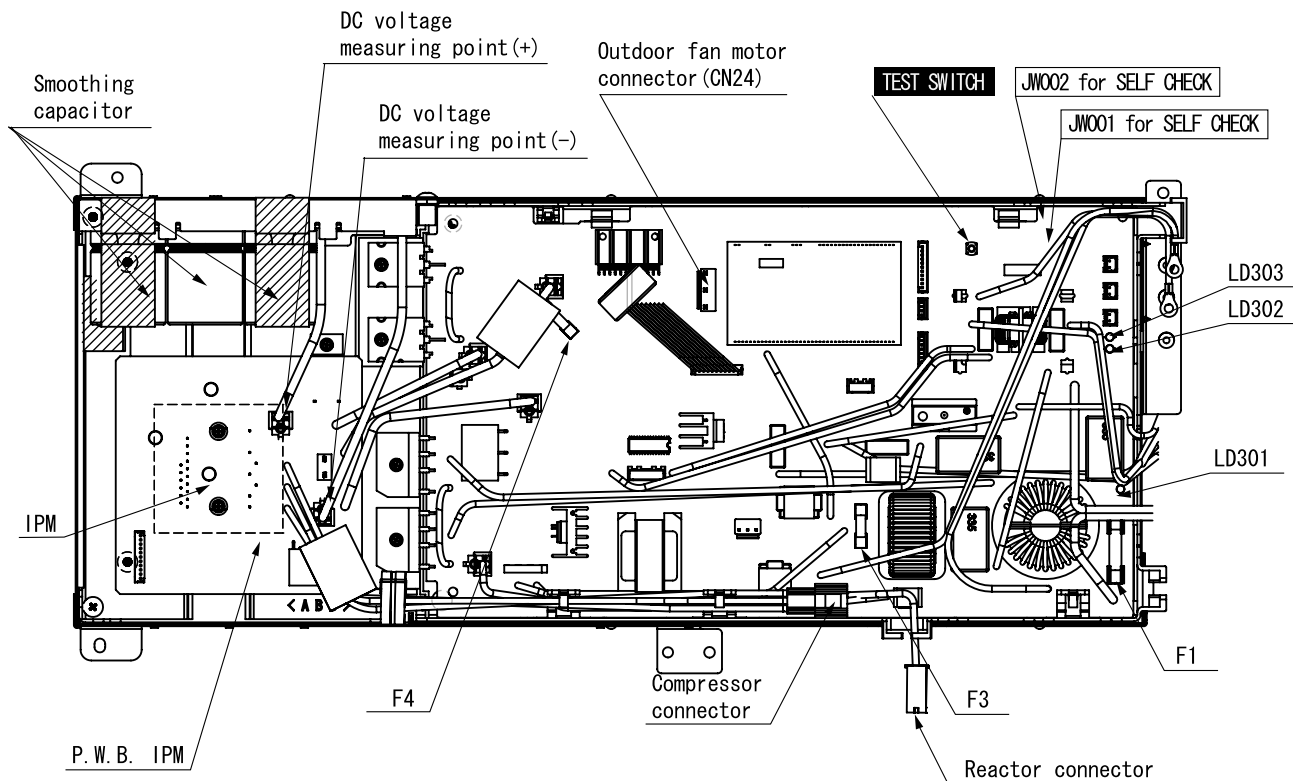

## ※ Caution

1. Turn OFF the breaker first before can start servicing.
2. Never operate the unit in this condition for more than 5 minutes.
3. If the checking is done with the compressor connector disconnected, the unit will continue normal operation when electrical part are normal, or it will repeat operating for approximate 1 minute and stop due to overload power limit cut
4. If interface signal (DC35V) terminal C and D are not connected when the outdoor unit TEST SWITCH is used for checking, LD301 will blink 9 times after operation to indicate a communication error.
5. To proceed with TEST SWITCH operation again, breaker must be turn OFF and ON it again. (TEST SWITCH will operate 1 time only once power is supplied)
6. When service operation is completed, restore the connection as original condition.

# LIGHTING MODE OF SELF-DIAGNOSIS LAMP

## 1 POSITION OF SELF-DIAGNOSIS LAMP

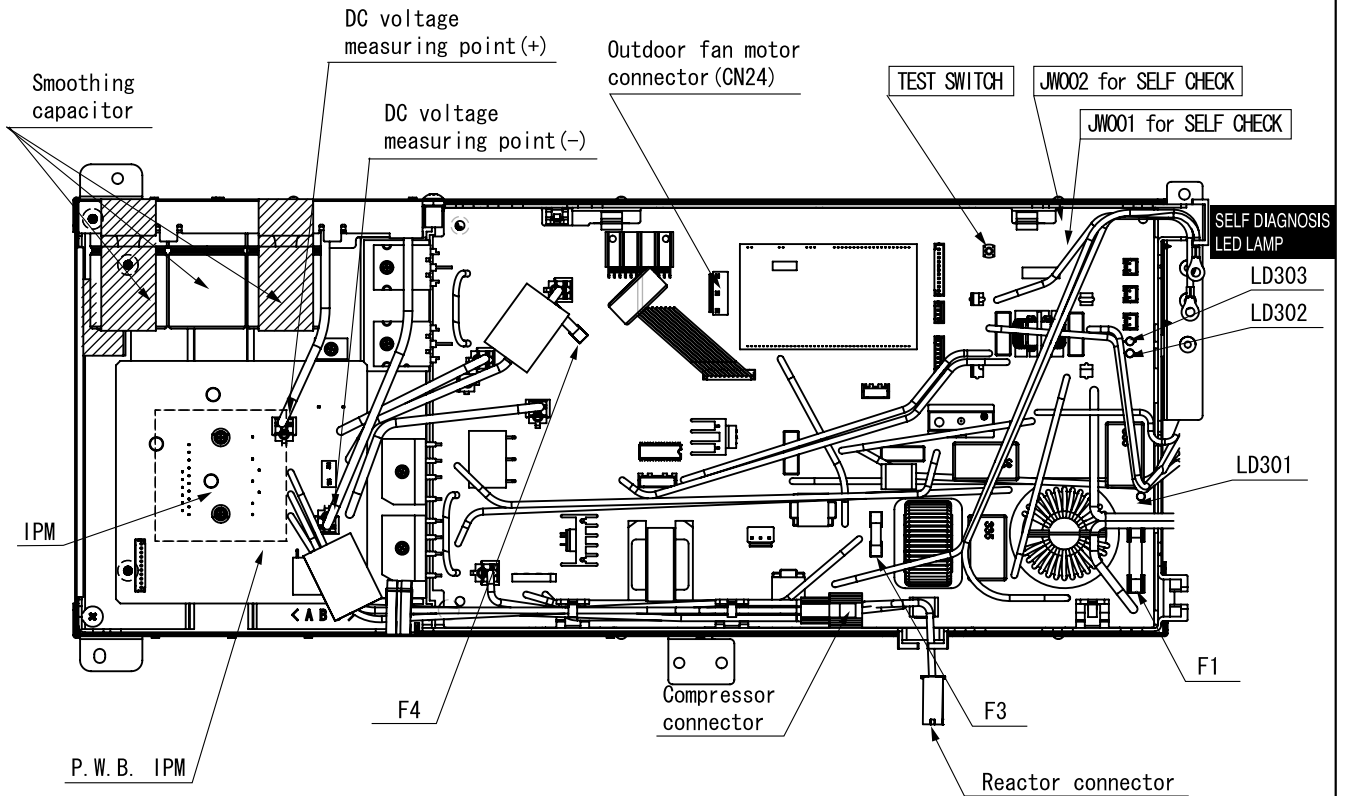

# LIGHTING MODE SELF-DIAGNOSIS LAMP

## 2 LIGHTING MODE SELF-DIAGNOSIS LAMP

**⚠ DANGER (DC360V)**

● SWITCH OFF MAIN POWER SUPPLY. ● DO NOT TOUCH ANY OTHER PARTS EXCEPT TEST (SERVICE) SWITCH WHEN SERVICE OPERATIONS ARE CONDUCTED. ● MAKE SURE THE LEVEL DC VOLTAGE BETWEEN TAB5/WHIT(+) AND TAB6/BLK(-) IS LESS THAN 0V.

**SELF-DIAGNOSIS LIGHTING MODE** ■ LIT □ OFF

1 TIME ■ LIT □ OFF

2 TIMES ■ LIT □ OFF

3 TIMES ■ LIT □ OFF

4 TIMES ■ LIT □ OFF

5 TIMES ■ LIT □ OFF

6 TIMES ■ LIT □ OFF

7 TIMES ■ LIT □ OFF

8 TIMES ■ LIT □ OFF

9 TIMES ■ LIT □ OFF

10 TIMES ■ LIT □ OFF

11 TIMES ■ LIT □ OFF

12 TIMES ■ LIT □ OFF

13 TIMES ■ LIT □ OFF

14 TIMES ■ LIT □ OFF

15 TIMES ■ LIT □ OFF

16 TIMES ■ LIT □ OFF

17 TIMES ■ LIT □ OFF

18 TIMES ■ LIT □ OFF

19 TIMES ■ LIT □ OFF

20 TIMES ■ LIT □ OFF

21 TIMES ■ LIT □ OFF

22 TIMES ■ LIT □ OFF

23 TIMES ■ LIT □ OFF

24 TIMES ■ LIT □ OFF

25 TIMES ■ LIT □ OFF

26 TIMES ■ LIT □ OFF

27 TIMES ■ LIT □ OFF

28 TIMES ■ LIT □ OFF

29 TIMES ■ LIT □ OFF

30 TIMES ■ LIT □ OFF

31 TIMES ■ LIT □ OFF

32 TIMES ■ LIT □ OFF

33 TIMES ■ LIT □ OFF

34 TIMES ■ LIT □ OFF

35 TIMES ■ LIT □ OFF

36 TIMES ■ LIT □ OFF

37 TIMES ■ LIT □ OFF

38 TIMES ■ LIT □ OFF

39 TIMES ■ LIT □ OFF

40 TIMES ■ LIT □ OFF

41 TIMES ■ LIT □ OFF

42 TIMES ■ LIT □ OFF

43 TIMES ■ LIT □ OFF

44 TIMES ■ LIT □ OFF

45 TIMES ■ LIT □ OFF

46 TIMES ■ LIT □ OFF

47 TIMES ■ LIT □ OFF

48 TIMES ■ LIT □ OFF

49 TIMES ■ LIT □ OFF

50 TIMES ■ LIT □ OFF

51 TIMES ■ LIT □ OFF

52 TIMES ■ LIT □ OFF

53 TIMES ■ LIT □ OFF

54 TIMES ■ LIT □ OFF

55 TIMES ■ LIT □ OFF

56 TIMES ■ LIT □ OFF

57 TIMES ■ LIT □ OFF

58 TIMES ■ LIT □ OFF

59 TIMES ■ LIT □ OFF

60 TIMES ■ LIT □ OFF

61 TIMES ■ LIT □ OFF

62 TIMES ■ LIT □ OFF

63 TIMES ■ LIT □ OFF

64 TIMES ■ LIT □ OFF

65 TIMES ■ LIT □ OFF

66 TIMES ■ LIT □ OFF

67 TIMES ■ LIT □ OFF

68 TIMES ■ LIT □ OFF

69 TIMES ■ LIT □ OFF

70 TIMES ■ LIT □ OFF

71 TIMES ■ LIT □ OFF

72 TIMES ■ LIT □ OFF

73 TIMES ■ LIT □ OFF

74 TIMES ■ LIT □ OFF

75 TIMES ■ LIT □ OFF

76 TIMES ■ LIT □ OFF

77 TIMES ■ LIT □ OFF

78 TIMES ■ LIT □ OFF

79 TIMES ■ LIT □ OFF

80 TIMES ■ LIT □ OFF

81 TIMES ■ LIT □ OFF

82 TIMES ■ LIT □ OFF

83 TIMES ■ LIT □ OFF

84 TIMES ■ LIT □ OFF

85 TIMES ■ LIT □ OFF

86 TIMES ■ LIT □ OFF

87 TIMES ■ LIT □ OFF

88 TIMES ■ LIT □ OFF

89 TIMES ■ LIT □ OFF

90 TIMES ■ LIT □ OFF

91 TIMES ■ LIT □ OFF

92 TIMES ■ LIT □ OFF

93 TIMES ■ LIT □ OFF

94 TIMES ■ LIT □ OFF

95 TIMES ■ LIT □ OFF

96 TIMES ■ LIT □ OFF

97 TIMES ■ LIT □ OFF

98 TIMES ■ LIT □ OFF

99 TIMES ■ LIT □ OFF

100 TIMES ■ LIT □ OFF

**SELF-DIAGNOSIS LIGHTING MODE** ■ LIT □ OFF

1 TIME ■ LIT □ OFF

2 TIMES ■ LIT □ OFF

3 TIMES ■ LIT □ OFF

4 TIMES ■ LIT □ OFF

5 TIMES ■ LIT □ OFF

6 TIMES ■ LIT □ OFF

7 TIMES ■ LIT □ OFF

8 TIMES ■ LIT □ OFF

9 TIMES ■ LIT □ OFF

10 TIMES ■ LIT □ OFF

11 TIMES ■ LIT □ OFF

12 TIMES ■ LIT □ OFF

13 TIMES ■ LIT □ OFF

14 TIMES ■ LIT □ OFF

15 TIMES ■ LIT □ OFF

16 TIMES ■ LIT □ OFF

17 TIMES ■ LIT □ OFF

18 TIMES ■ LIT □ OFF

19 TIMES ■ LIT □ OFF

20 TIMES ■ LIT □ OFF

21 TIMES ■ LIT □ OFF

22 TIMES ■ LIT □ OFF

23 TIMES ■ LIT □ OFF

24 TIMES ■ LIT □ OFF

25 TIMES ■ LIT □ OFF

26 TIMES ■ LIT □ OFF

27 TIMES ■ LIT □ OFF

28 TIMES ■ LIT □ OFF

29 TIMES ■ LIT □ OFF

30 TIMES ■ LIT □ OFF

31 TIMES ■ LIT □ OFF

32 TIMES ■ LIT □ OFF

33 TIMES ■ LIT □ OFF

34 TIMES ■ LIT □ OFF

35 TIMES ■ LIT □ OFF

36 TIMES ■ LIT □ OFF

37 TIMES ■ LIT □ OFF

38 TIMES ■ LIT □ OFF

39 TIMES ■ LIT □ OFF

40 TIMES ■ LIT □ OFF

41 TIMES ■ LIT □ OFF

42 TIMES ■ LIT □ OFF

43 TIMES ■ LIT □ OFF

44 TIMES ■ LIT □ OFF

45 TIMES ■ LIT □ OFF

46 TIMES ■ LIT □ OFF

47 TIMES ■ LIT □ OFF

48 TIMES ■ LIT □ OFF

49 TIMES ■ LIT □ OFF

50 TIMES ■ LIT □ OFF

51 TIMES ■ LIT □ OFF

52 TIMES ■ LIT □ OFF

53 TIMES ■ LIT □ OFF

54 TIMES ■ LIT □ OFF

55 TIMES ■ LIT □ OFF

56 TIMES ■ LIT □ OFF

57 TIMES ■ LIT □ OFF

58 TIMES ■ LIT □ OFF

59 TIMES ■ LIT □ OFF

60 TIMES ■ LIT □ OFF

61 TIMES ■ LIT □ OFF

62 TIMES ■ LIT □ OFF

63 TIMES ■ LIT □ OFF

64 TIMES ■ LIT □ OFF

65 TIMES ■ LIT □ OFF

66 TIMES ■ LIT □ OFF

67 TIMES ■ LIT □ OFF

68 TIMES ■ LIT □ OFF

69 TIMES ■ LIT □ OFF

70 TIMES ■ LIT □ OFF

71 TIMES ■ LIT □ OFF

72 TIMES ■ LIT □ OFF

73 TIMES ■ LIT □ OFF

74 TIMES ■ LIT □ OFF

75 TIMES ■ LIT □ OFF

76 TIMES ■ LIT □ OFF

77 TIMES ■ LIT □ OFF

78 TIMES ■ LIT □ OFF

79 TIMES ■ LIT □ OFF

80 TIMES ■ LIT □ OFF

81 TIMES ■ LIT □ OFF

82 TIMES ■ LIT □ OFF

83 TIMES ■ LIT □ OFF

84 TIMES ■ LIT □ OFF

85 TIMES ■ LIT □ OFF

86 TIMES ■ LIT □ OFF

87 TIMES ■ LIT □ OFF

88 TIMES ■ LIT □ OFF

89 TIMES ■ LIT □ OFF

90 TIMES ■ LIT □ OFF

91 TIMES ■ LIT □ OFF

92 TIMES ■ LIT □ OFF

93 TIMES ■ LIT □ OFF

94 TIMES ■ LIT □ OFF

95 TIMES ■ LIT □ OFF

96 TIMES ■ LIT □ OFF

97 TIMES ■ LIT □ OFF

98 TIMES ■ LIT □ OFF

99 TIMES ■ LIT □ OFF

100 TIMES ■ LIT □ OFF

**STRUCTURE OF ELECTRICAL**

IPM  
CAPA P.W.B  
DC INPUT (L)  
MAIN P.W.B  
FUSE F2  
OUTDOOR FAN MOTOR CONNECTOR (CN24)  
TEST/SERVICE SWITCH  
FUSE F3  
FUSE F1

SELF-DIAGNOSIS USED-JW001  
SELF-DIAGNOSIS USED-JW002  
LD301 LD302  
LD303

WHEN SELF-DIAGNOSIS BLINKS 23.4 AND 5 TIMES HAPPEN TO DETERMINE WHETHER COMPRESSOR OR ELECTRICAL UNIT FAULTY. BELOW DIAGNOSIS CAN BE FOLLOWED.

SELF-DIAGNOSIS METHOD

- SWITCH OFF MAIN POWER SUPPLY.
- SHORT CIRCUIT BETWEEN JW001 AND JW002.
- SWITCH ON MAIN POWER SUPPLY-LD301 WILL BLINK 1 TIME.
- (WITHIN 3 MINUTES) PRESS TEST/SERVICE SWITCH FOR 1 SEC. OR MORE.
- SELF-DIAGNOSIS RESULT WILL BE SHOWN-LD303 WILL ON (LIT) AND LD301 WILL BLINKING. THEN REFER TO DIAGNOSIS TABLE 2.
- SWITCH OFF MAIN POWER SUPPLY. THEN RELEASE BACK JW001 AND JW002 TO ORIGINAL CONDITION (NO SHORT CIRCUIT CONDITION).
- ME STEP NO.6 NOT CARRIED OUT. THE SYSTEM WILL NOT OPERATE PROPERLY AFTER RESTORE THE POWER SUPPLY.

**TABLE 2 : DURING SELF-DIAGNOSIS COMPLETED**

SELF-DIAGNOSIS LIGHTING MODE	■ LIT □ BLINKING □ OFF
REPAIR METHOD	REPAIR METHOD
SELF-DIAGNOSIS RESULT	REPAIR METHOD
ELECTRICAL OK	○ CHANGE COMPRESSOR
PEAK CURRENT CUT OFF	○ CHANGE P.W.Bs
COMPRESSOR CURRENT ABNORMAL	○ F. COMPRESSOR CONNECTOR LOOSE OR NG ○ CHECK CONNECTOR CONDITION ○ CHECK COMPRESSOR CHANGE P.W.Bs
DC VOLTAGE ABNORMAL	○ F. AC VOLTAGE INPUT ABNORMAL ○ F. FOLLOW STANDARD AC VOLTAGE INPUT ○ AC INPUT NORMAL (WITHIN ± 0.5%) ○ CHANGE P.W.Bs.
EEPROM READING ERROR	○ CHANGE P.W.B. MAIN

**TABLE 3 : OUTDOOR FAN MOTOR INSPECTION (SELF-DIAGNOSIS)**

- SWITCH OFF MAIN POWER SUPPLY.
- DISCONNECT OUTDOOR FAN MOTOR CONNECTOR FROM CONNECTOR CN24 OF P.W.B MAIN.
- ROTATE THE OUTDOOR FAN SHAFT TO CONFIRM THE FAN MOTOR MOVEMENT EITHER NORMAL OR ABNORMAL.
- CHECK THE RESISTANCE VALUE BETWEEN PN TERMINAL SHOULD BE WITHIN 20 TO 50 Ohm.

\*CONNECT BACK THE OUTDOOR FAN CONNECTOR ONCE FINISH DO INSPECTION.

OTHER INSPECTION:

- DIAGNOSIS FOR REVERSING VALVE OPERATION ERROR.  
-CHECK REVERSING VALVE WIRE CONNECTION EITHER WIRE BROKEN OR NOT. IF OK, CHECK FUSE F3. IF BROKEN, REPLACE FUSE OR P.W.Bs.
- DIAGNOSIS FOR COMMUNICATION SIGNAL ERROR OR OUTDOOR NOT FUNCTIONAL.  
-CHECK WIRING CONNECTION BETWEEN INDOOR AND OUTDOOR.

# CHECKING THE REMOTE CONTROLLER

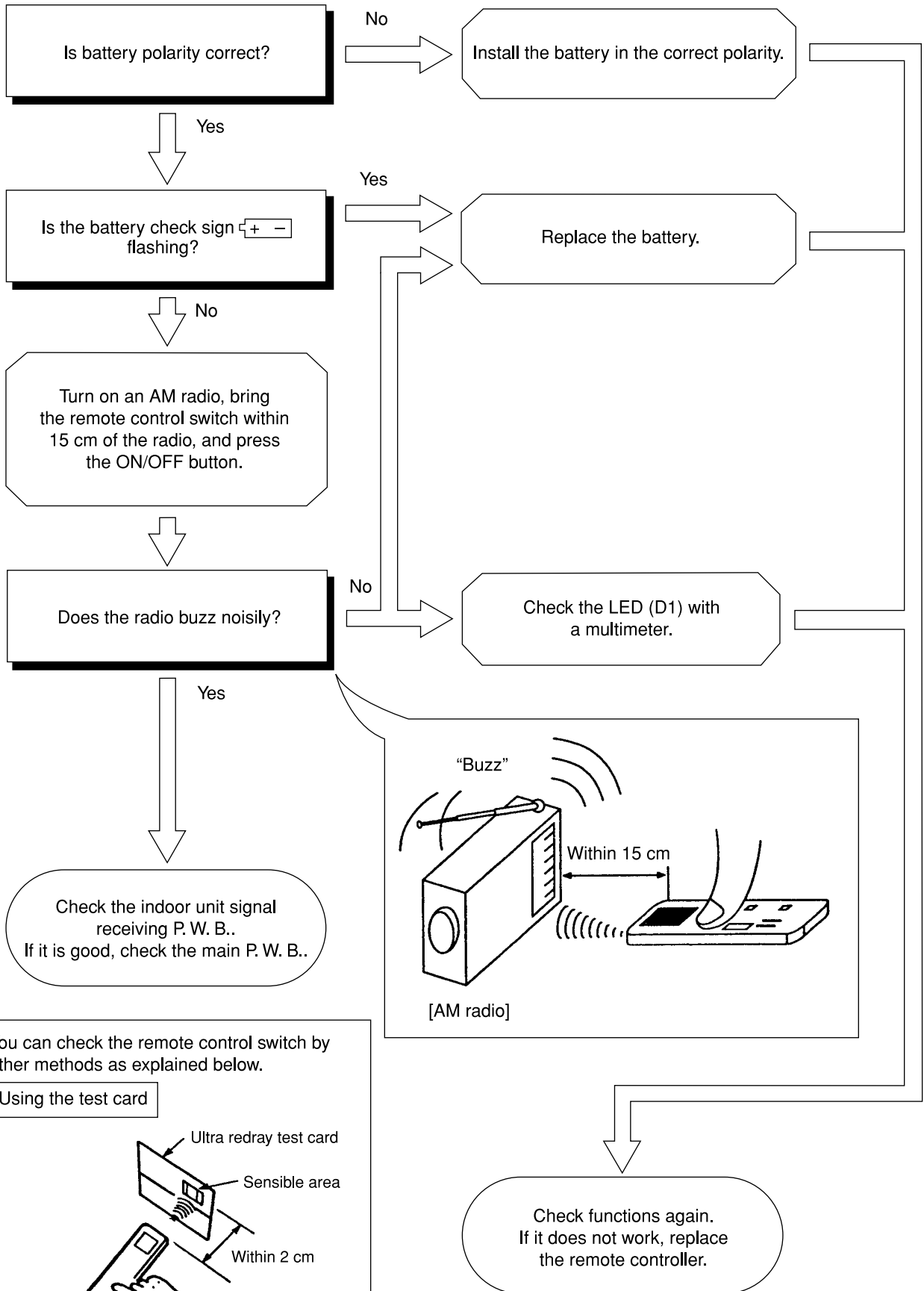

You can check the remote control switch by other methods as explained below.

## Using the test card

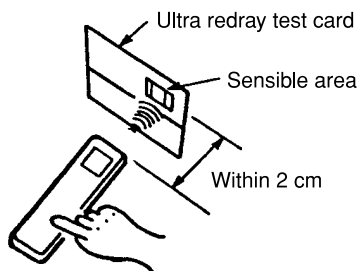

The sensible area should flash in orange when you operate the remote control unit if it is good.

# CHECKING THE REFRIGERATING CYCLE

(JUDGING BETWEEN GAS LEAKAGE AND COMPRESSOR DEFECTIVE)

## 1. Troubleshooting procedure (No operation, No heating, No cooling)

Connect U, V, W phase leads to the power module again and operate the air conditioner.

Is the self-diagnosis lamp mode as shown on the right?

Lighting mode Self-diagnosis lamp	Blinks 2 times	Blinks 3 times	Blinks 4 times	Blinks 5 times	Blinks 6 times	Blinks 8 times
LD301						
Time until the lamp lights	Approx. 10 seconds			Approx. 10 seconds	Within Approx. 30 seconds	Approx. 10 seconds
Possible malfunctioning part	Compressor				Gas leakage	Compressor

 Blinking       off

YES

Stop to operate and check the gas pressure in balancing mode.

Normal  
(0.39-0.98 MPaG)  
(4-10 kg/cm<sup>2</sup>G)

● Checking the system power module

Gas leaking  
(less than 4kg/cm<sup>2</sup>G)  
(less than 0.39 MPaG)

When the self-diagnosis lamp lights in the same condition as above.

Gas leaks.  
Repair and seal refrigerant.

The compressor is defective. Replace it and seal refrigerant.

( If the compressor checker for an inverter type air conditioner is available, re-check using it. )

Perform a final check of operation.

# PARTS LIST AND DIAGRAM

## INDOOR UNIT MODEL : RAK-60PPA

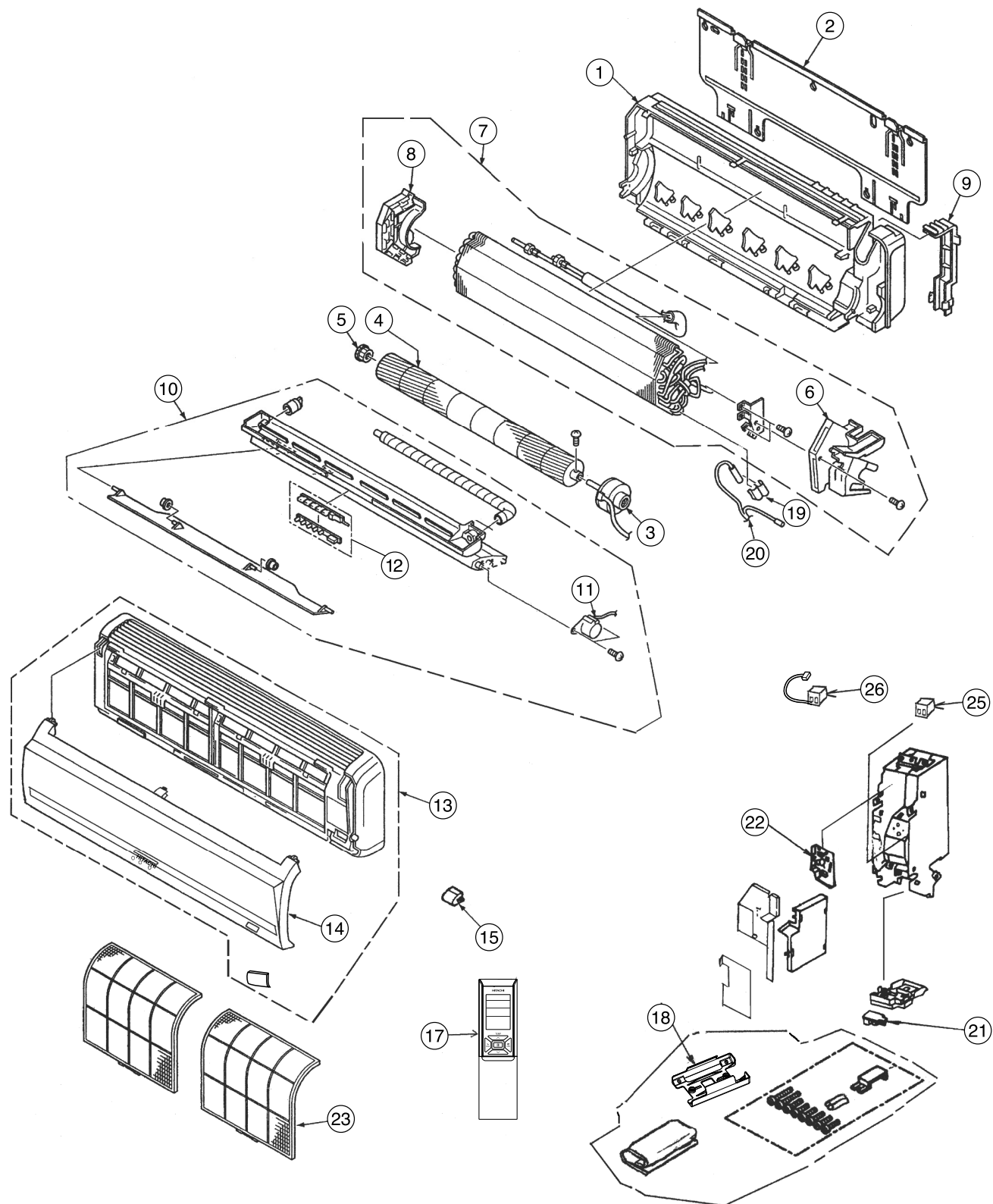



**MODEL RAK-60PPA**

<b>NO.</b>	<b>PART NO. RAK-60PPA</b>	<b>Q'TY / UNIT</b>	<b>PARTS NAME</b>
1	PMRAS-70YHA 001	1	CABINET
2	PMRAS-40CNH2 R23	1	MOUNTING PLATE
3	PMRAK-60PPA R04	1	FAN MOTOR
4	PMRAS-70YHA R10	1	TANGENTIAL FAN
5	PMRAS-25CNH2 005	1	P-BEARING ASSY
6	PMRAS-51CHA1 004	1	FAN MOTOR BASE
7	PMRAK-60PPA R03	1	CYCLE ASSY
8	PMRAS-51CHA1 R20	1	FAN COVER
9	PMRAS-18CP5 003	1	PIPE SUPPORT
10	PMRAS-70YHA R03	1	DRAIN PAN ASSY
11	PMRAS-18CP6 R02	1	AUTO SWEEP MOTOR
12	PMRAS-70YHA R07	1	P.W.B (LED)
13	PMRAS-60YH5 001	1	FRONT COVER ASSEMBLY
14	PMRAS-60YH5 002	1	FRONT PANEL
15	PMRAS-10C7M 008	3	CAP
17	PMRAI-25RPA R02	1	REMOTE CONTROL ASSEMBLY
18	PMRAK-50PPA R07	1	REMOTE CONTROL SUPPORT
19	PMRAS-40CNH2 R26	1	THERMISTOR SUPPORT
20	PMRAS-70YHA R12	1	THERMISTOR
21	PMRAK-60PPA R02	1	P.W.B (RECEIVER)
22	PMRAK-60PPA R01	1	P.W.B (MAIN)
23	PMRAS-60YH7 R02	2	FILTER
25	PMRAC-07CV1 R06	1	TERMINAL BOARD (2P)
26	PMRAS-70YHA R11	1	TERMINAL BOARD (2P)

# PARTS LIST AND DIAGRAM

## OUTDOOR UNIT MODEL : RAC-60WPA

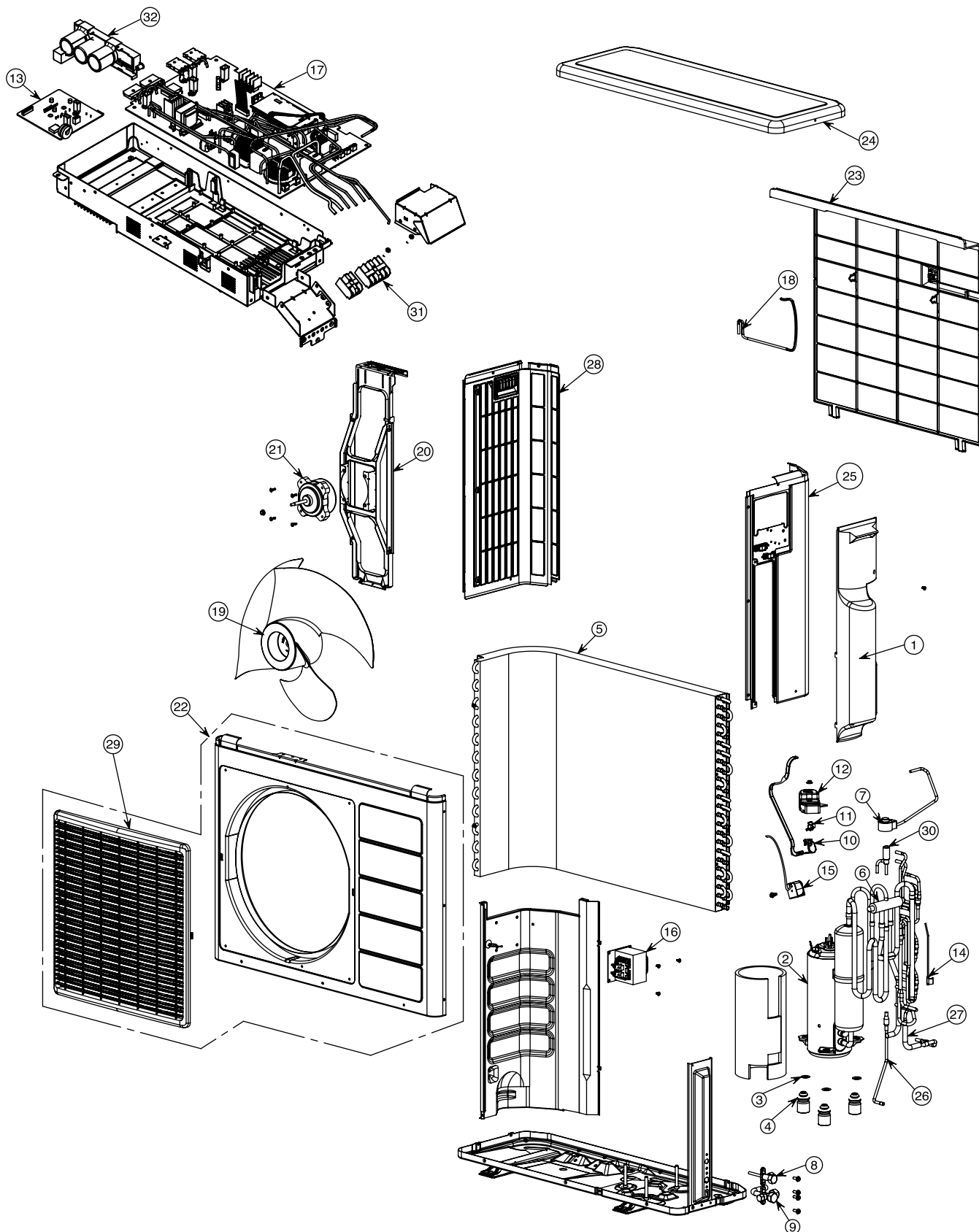

**MODEL RAC-60WPA**

NO.	PART NO. RAC-60WPA		Q'TY / UNIT	PARTS NAME
1	PMRAC-60YHA2	S04	1	SV-COVER
2	PMRAC-60YH7	S01	1	COMPRESSOR
3	KPNT1	001	4	PUSH NUT
4	RAC-2226HV	805	3	COMPRESSOR RUBBER
5	PMRAC-50NH4	S02	1	CONDENSER
6	PMRAC-X24CAT	S02	1	REVERSING VALVE
7	PMRAC-25NPA	S02	1	ELECTRICAL EXPANSION COIL
8	PMRAC-50NH4	S03	1	VALVE (2S)
9	PMRAC-60YHA3	S06	1	VALVE (4S)
10	PMRAC-40CNH2	S14	1	THERMISTOR (OH)
11	PMRAC-25NH4	S09	1	OVERHEAT THERMISTOR SUPPORT
12	PMRAC-X13CX	906	1	OVERLOAD RELAY COVER
13	PMRAC-50YH7A	S02	1	P.W.B (IPM)
	PMRAC-50YH7A	S92	1	(OPTIONAL) P.W.B (IPM) TUFFY
14	PMRAC-50YHA2	S07	1	THERMISTOR (DEFROST)
15	PMRAC-50YHA2	S09	1	COIL (REVERSING VALVE)
16	PMRAC-50YHA2	S04	1	REACTOR
17	PMRAC-60WPA	S01	1	P.W.B (MAIN)
	PMRAC-60WPA	S91	1	(OPTIONAL) P.W.B (MAIN) TUFFY
18	PMRAC-50YHA2	S08	1	THERMISTOR (OUTSIDE TEMPERATURE)
19	PMRAC-70YHA	S07	1	PROPELLER FAN
20	PMRAC-40CNH2	S18	1	SUPPORT (FAN MOTOR)
21	PMRAC-50YHA2	S03	1	FAN MOTOR
22	PMRAC-50YH7	S04	1	CABINET
23	PMRAC-40CNH2	921	1	NET
24	PMRAC-40CNH2	922	1	TOP COVER
25	PMRAC-60YHA2	S06	1	SIDE PLATE-R
26	PMRAC-60YHA2	S02	1	STRAINER (PIPE)
27	PMRAC-60YHA2	S03	1	STRAINER (COND)
28	PMRAC-40CNH2	926	1	SIDE PLATE-L
29	PMRAM-52QH5	S03	1	GRILL
30	PMRAC-25NPA	S03	1	EXPANSION VALVE
31	PMRAC-51CHA1	S03	1	TERMINAL BOARD (4P)
32	PMRAC-50YH7A	S03	1	P.W.B (CAPA-BOARD)

# HITACHI

**RAK-60PPA / RAC-60WPA**

**PM NO. 0540E**

Printed in Malaysia